

Фитинги с врезными кольцами Hydroscand используются для трубопроводов, в основном в гидравлических и пневматических системах.

Компания Hydroscand может поставлять фитинги с врезными кольцами из нержавеющей стали, предназначенные для агрессивных окружающих сред и жидкостей.

Рабочее давление/PN до 63 МПа/630 бар, для труб с наружным диаметром 4 – 42 мм. Параметры давления соответствуют требованиям стандарта DIN 2353.

Фитинги с врезными кольцами характеризуются очень жесткой трубной сборкой, стойкостью к вибрациям и импульсам давления. Фитинги могут быть разобраны/собраны более одного раза.

Во время сборки врезного кольца две кромки кольца впрессовываются в трубу, что создает механическую опору. Шлиц 1 начинает проникать в трубу еще до того, как шлиц 2 начнет врезаться в трубу. После сборки шлиц три впрессовывается между конусом и трубой и обеспечивает положение, при котором вибрация не достигает режущих шлицев, шлиц четыре не допускает радиального перемещения. Конструкция профиля кольца обеспечивает очень прочную, осевую и радиальную опору. Напряжение переносится по всей длине врезного кольца.

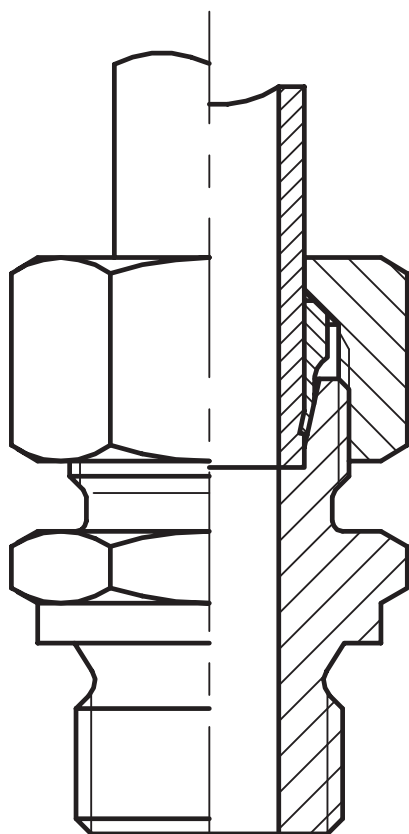

Группа продукта 600



Фитинги

Страница

6171	GE -R/C LL	213
6172	GE -MK/C LL	213
6177	GE -NPT LL	213
6173	WE -R/C LL	213
6174	WE -MK/C LL	213
6175	WE -NPT LL	213
6182	TE -R/C LL	213
6181	TE -MK/C LL	213
6184	LE -R/C LL	214
6183	LE -MK/C LL	214
6176	G LL	214
6178	W LL	214
6187	T LL	214
6188	K LL	214
6189	RED LL	214
6186	SWVE -G LL	215
6185	SWVE -M LL	215
6179	D LL - Врезное кольцо	215
6180	M LL - Гайка	215
6002	GE -GA	216
6003	GE -GB	216
6003S	GE -GB 60° трубная резьба	217
6003	GE - GB корпус	217
6006	GE - MB	218
6006	GE - MB ко рпус	218
6007	GE - NPT	218
6008	GE - UNF	219
6009	GE - G/ED	219
6009	GE - G/ED корпус	220
6010	GE - M/ED	220
6010	GE - M/ED корпус	220
6011	WE - R/C	221
6013	WE - GB	221
6014	WE - MK/C	221
6016	WE - MB	221
6017	WE - NPT	222
6021	TE - R/C	222
6023	TE - GB	222
6031	LE - R/C	223
6033	LE - GB	223
6034	LE - MK/C	223
6036	LE - MB	223
6035	DKO	223
6235	DKLO-DKSO	223
6041	G	224
6042	W	224
6043	T	224
6044	K	225
6045	SV	225
6046	WSV	225
6047	AS	225
6048	ESV	226
6049	WAS	226
6050	EVW	226
6051	EVWO	226
6060	EVT	227
6061	EVTO	227
6070	EVL	227
6071	EVLO	227
6083	EVGE - GB	228
6089	EVGE - G/ED	228
6090	EVGEO - G/ED	229
6092	EVGEO - M/ED	229

Группа продукта 600



Фитинги	Страница	
6101	GAI - G	229
6102	GAI - M	229
6103	MAV - G	230
6104	MAV - EV - G	230
6105	RED	230
6107	KOR - L	231
6109	KORO - L	231
6607	KOR - S	232
6609	KORO - S	232
6110	WHB - G	233
6118	WHO - G	233
6111	WHB - M	233
6119	WHO - M	233
6112	DSVW - G	234
6114	DSVT - G	234
6116	WHBT - G	234
6028	SWVE - G	234
6120	RHD	235
6121	RHV - G - ED	235
6123	RHZ - G - ED	235
6126	RHR	235
6127	RHDI	235
6110-00/03	УПЛОТНИТЕЛЬНОЕ КОЛЬЦО для 6110, 6116/6111	236
6130	PL	236
6131	HOA	236
6149-01	D	236
6150	M	237
6151	FM	237
6152-03	D - ED B4	237
6153	GM-стопорная гайка	238
6160	SN	238
6160-50	Кольцевое уплотнение для 6160	238

Материал

Фитинги с врезными кольцами Hydroscand изготавливаются из автоматной стали для винтов или из кованных материалов. Обычно, обработка поверхности – электроцинкование и хром (6), несвязанный, белый. Уплотнительное кольцо стандарт NBR (бутадиен-нитрильный каучук), температура до +90°C.

Соединения

Трубная дюймовая резьба G (резьба Витворта), конические трубные резьбы R, конические резьбы NPTF (внутренняя коническая трубная резьба США), UNF (унифицированная тонкая резьба), метрическая резьба. Конус врезного кольца соответствует конусу DIN W 3861 24°. Для различных размеров соединений вы найдете стандартный размер, маркированный жирным шрифтом.

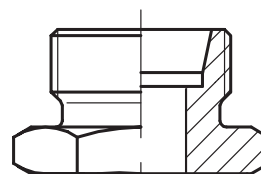

Одобрения

Компания Hydroscand может поставлять фитинги с различными стандартами/сертификатами: DVGW, Norske Veritas, Немецкий Ллойд, ISO 9002.

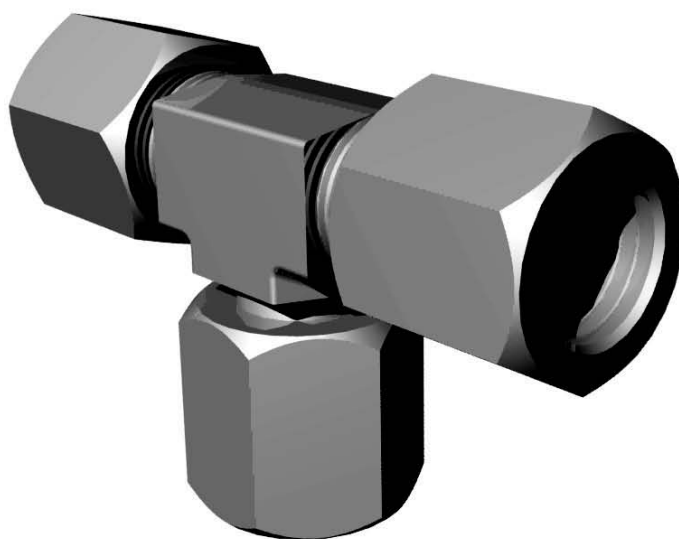



Параметры давления для фитингов с врезными кольцами

Параметры давления для трубных фитингов с наружным диаметром:

			LL				L								S											
			4	5	6	8	6	8	10	12	15	18	22	28	35	42	6	8	10	12	14	16	20	25	30	38
6001	6003	6006																								
6007	6008	6009																								
6010	6011	6013																								
6014	6016	6017																								
6021	6024	6027																								
6034	6035	6036																								
6041	6042	6043																								
6044	6045	6046																								
6047	6048	6049	100																							
6050	6051	6060																								
6061	6070	6071																								
6087	6089	6090																								
6092	6101	6102																								
6105	6107	6109																								
6130	6185	6216																								
6217	6218	6219																								
6537																										
6088	6172		100					400			315		250				630					400			315	
6110	6111	6116						400				315		250				400				315			250	
6118	6119																									
6083	6086																									
6103	6104																									
6018								315			250			160			315				250			200	160	
6002																										
6128			100																							
6023	6033																									
6112	6114																									
6118	6119		100																							
6120	6121	6123																								

*= коэффициент надежности 3

**= коэффициент надежности мин. 1,6

Момент затяжки для соединительного конца

ПРИМЕЧАНИЕ! Следующие моменты затяжки не могут применяться на соединениях с врезными кольцами, см. сборочные инструкции на следующей странице. Они также не применяются для фитингов типа "банджо" или конических резьбовых фитингов.

Серия	Ø трубы	Резьба BSP		Момент (Нм)		Метрическая резьба	Момент (Нм)		Резьба UN/UNF		Момент (Нм)	
		форма В	форма E,H,G	форма В	форма E,H,G		форма В	форма E,H,G	Момент (Нм)			
LL	4	G 1/8"		20		M 8x1,0		10				
	5	G 1/8"		20		M 8x1,0		10				
	6	G 1/8"		20		M 10x1,0		20				
	8	G 1/8"		20		M 10x1,0		20				
L	6	G 1/8"		20		M 10x1,0		20		7/16"-20 UNF		20
	8	G 1/4"		45	45	M 12x1,5		30	30	1/2"-20 UNF		25
	10	G 1/4"		45	45	M 14x1,5		45	45	1/2"-20 UNF		25
	12	G 3/8"		70	70	M 16x1,5		60	55	9/16"-18 UNF		30
	15	G 1/2"		130	85	M 18x1,5		80	70	3/4"-16 UNF		45
	18	G 1/2"		130	85	M 22x1,5		130	120	3/4"-16 UNF		55
	22	G 3/4"		170	170	M 26x1,5		180	170	1 1/16"-12 UN		85
	28	G 1"		330	330	M 33x2,0		330	330	1 5/16"-12 UN		130
	35	G 1 1/4"		510	430	M 42x2,0		470	430	1 5/8"-12 UN		170
	42	G 1 1/2"		600	510	M 48x2,0		600	510	1 7/8"-12 UN		180
S	6	G 1/4"		55	55	M 12x1,5		40	40	1/2"-20 UNF		25
	8	G 1/4"		55	55	M 14x1,5		55	55	1/2"-20 UNF		25
	10	G 3/8"		85	80	M 16x1,5		80	70	9/16"-18 UNF		35
	12	G 3/8"		85	80	M 18x1,5		105	85	9/16"-18 UNF		35
	14	G 1/2"		150	110	M 20x1,5		150	120	3/4"-16 UNF		60
	16	G 1/2"		150	110	M 22x1,5		170	130	3/4"-16 UNF		60
	16									7/8"-14 UNF		85
	20	G 3/4"		280	170	M 27x1,5		200	170	1 1/16"-12 UN		150
	25	G 1"		330	330	M 33x2,0		390	330	1 5/16"-12 UN		230
	30	G 1 1/4"		510	430	M 42x2,0		510	430	1 5/8"-12 UN		250
38	G 1 1/2"		680	510	M 48x2,0		680	510	1 7/8"-12 UN		320	



СБОРОЧНЫЕ ИНСТРУКЦИИ

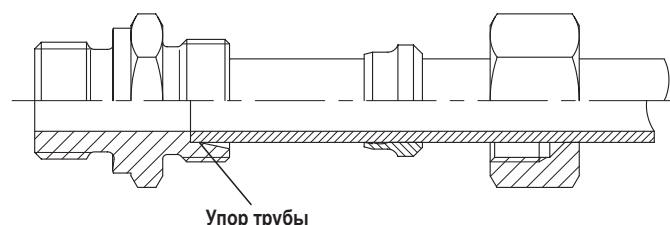
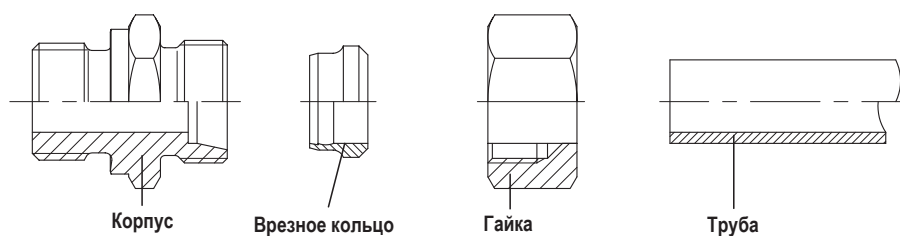

1. Отрезать трубу под углом 90° (не использовать труборезы).
2. Снять с трубы заусенцы изнутри и снаружи.
3. Смазать резьбу корпуса, врезное кольцо и внутреннюю часть гайки. Для фитингов из углеродистой стали используйте минеральное масло. Для фитингов из нержавеющей стали используйте специальный высококачественный смазочный материал, например, 5650-00-05, см. страницу 166.
4. Переместить гайку и врезное кольцо на трубу. ПРИМЕЧАНИЕ! Режущий конец врезного кольца должен смотреть в направлении конца трубы, в противном случае сборка будет неправильной.
5. Затянуть гайку от руки, насколько это практически возможно.
6. Прижать трубу к упору в корпусе соединительной муфты. Затянуть гайку примерно на 1 1/2 оборота с помощью ключа. ПРИМЕЧАНИЕ! Труба не должна поворачиваться!
7. Сборка с закаленным, предварительно установленным корпусом: Прижать трубу к упору в корпусе соединительной муфты; затянуть гайку примерно на 1 1/4 оборота. ПРИМЕЧАНИЕ! Труба не должна поворачиваться!
8. Окончательная сборка узла на предварительно установленном корпусе: Завернуть гайку от руки, насколько это практически возможно, затем гайка должна быть дополнительно затянута примерно на 1/2 -3/4 оборота. Эта информация получена благодаря полной предварительной сборке нашей соединительной муфты.
9. Ослабить гайку и проверить, чтобы врезное кольцо было впрессовано в видимую стенку. Если этого не происходит, следует его слегка подтянуть. Если врезное кольцо может вращаться на трубе, затяжка бесполезна.
10. Ослабить гайку. Видимый выход фланца должен заполнить пространство впереди торца врезной кромки. Важное значение имеет следующий факт: может врезное кольцо вращаться или не может.

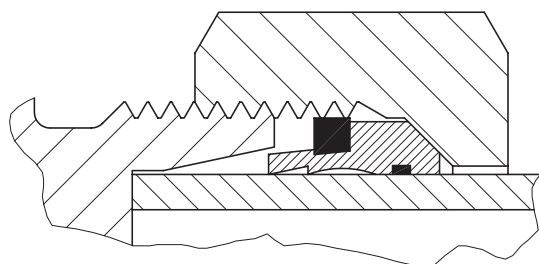

Перед затяжкой гайки

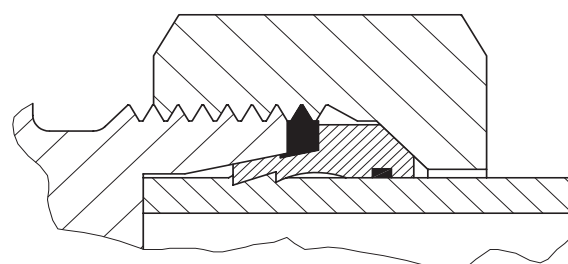

После затяжки гайки



Врезная кромка

6171
GE-R/C
ПРЯМОЙ ФИТИНГ
РЕЗЬБА R (BSPT), НАРУЖНАЯ

C DIN 3852

Код	Тип	Диам. трубы	Резьба
6171-04-02	GE 4 LL	4mm	R 1/8"
6171-05-02	GE 5 LL	5mm	R 1/8"
6171-06-02	GE 6 LL	6mm	R 1/8"
6171-08-02	GE 8 LL	8mm	R 1/8"
6171-08-04	GE 8 LL	8mm	R 1/4"

Коническое уплотнение

6174
WE-MK/C
УГЛОВОЙ ФИТИНГ 90°
РЕЗЬБА M, КОНИЧЕСКАЯ, НАРУЖНАЯ

C DIN 3852

Код	Тип	Диам. трубы	Резьба
6174-04-08	WE 4 LL	4mm	M8 x 1 k
6174-05-08	WE 5 LL	5mm	M8 x 1 k
6174-06-06	WE 6 LL	6mm	M6 x 1 k
6174-06-08	WE 6 LL	6mm	M8 x 1 k
6174-06-10	WE 6 LL	6mm	M10 x 1 k
6174-08-10	WE 8 LL	8mm	M10 x 1 k

Врезная кромка

6172
GE-MK/C
ПРЯМОЙ ФИТИНГ
РЕЗЬБА M, КОНИЧЕСКАЯ, НАРУЖНАЯ

C din 3852

Код	Тип	Диам. трубы	Резьба
6172-04-08	GE 4 LL	4mm	M8 x 1 k
6172-05-08	GE 5 LL	5mm	M8 x 1 k
6172-06-06	GE 6 LL	6mm	M6 x 1 k
6172-06-08	GE 6 LL	6mm	M8 x 1 k
6172-06-10	GE 6 LL	6mm	M10 x 1 k
6172-08-10	GE 8 LL	8mm	M810x 1 k

Коническое уплотнение

6175
WE-NPT
УГЛОВОЙ ФИТИНГ 90°
БЕЗ ПРОКЛАДОЧНЫХ УПЛОТНЕНИЙ, ТРУБНАЯ РЕЗЬБА (NPT), НАРУЖНАЯ

ANSI/ASME
B1.20.1-1983

Код	Тип	Диам. трубы	Резьба
6175-04-02	WE 4 LL	4mm	1/8"-27 NPT
6175-05-02	WE 5 LL	5mm	1/8"-27 NPT
6175-06-02	WE 6 LL	6mm	1/8"-27 NPT
6175-08-02	WE 8 LL	8mm	1/8"-27 NPT

Коническое уплотнение

6177
GE-NPT
ПРЯМОЙ ФИТИНГ,
БЕЗ ПРОКЛАДОЧНЫХ
УПЛОТНЕНИЙ, ТРУБНАЯ РЕЗЬБА (NPT), НАРУЖНАЯ

ANSI/ASME
B1.20.1-1983

Код	Тип	Диам. трубы	Резьба
6177-04-02	GE 4 LL	4mm	1/8"-27 NPT
6177-05-02	GE 5 LL	5mm	1/8"-27 NPT
6177-06-02	GE 6 LL	6mm	1/8"-27 NPT
6177-08-02	GE 8 LL	8mm	1/8"-27 NPT

Врезная кромка

6182
TE-R/C
Т-ОБРАЗНЫЙ ФИТИНГ
РЕЗЬБА R (BSPT), НАРУЖНАЯ

C DIN 3852

Код	Тип	Диам. трубы	Резьба
6182-04-02	TE 4 LL	4mm	R 1/8"
6182-05-02	TE 5 LL	5mm	R 1/8"
6182-06-02	TE 6 LL	6mm	R 1/8"
6182-08-02	TE 8 LL	8mm	R 1/8"

Коническое уплотнение

6173
WE-R/C
УГЛОВОЙ ФИТИНГ 90°
РЕЗЬБА R (BSPT), НАРУЖНАЯ

C DIN 3852

Код	Тип	Диам. трубы	Резьба
6173-04-02	WE 4 LL	4mm	R 1/8"
6173-05-02	WE 5 LL	5mm	R 1/8"
6173-06-02	WE 6 LL	6mm	R 1/8"
6173-08-02	WE 8 LL	8mm	R 1/8"
6173-12-04	WE 12 LL	12mm	R 1/4"

Врезная кромка

6181
TE-MK/C
Т-ОБРАЗНЫЙ ФИТИНГ
РЕЗЬБА M, КОНИЧЕСКАЯ, НАРУЖНАЯ

C din 3852

Код	Тип	Диам. трубы	Резьба
6181-04-08	TE 4 LL	4mm	M8 x 1 k
6181-05-08	TE 5 LL	5mm	M8 x 1 k
6181-06-10	TE 6 LL	6mm	M10 x 1 k
6181-08-10	TE 8 LL	8mm	M10 x 1 k

ПРИМЕЧАНИЕ! Все фитинги с врезными кольцами могут также поставляться без гайки и врезного кольца.

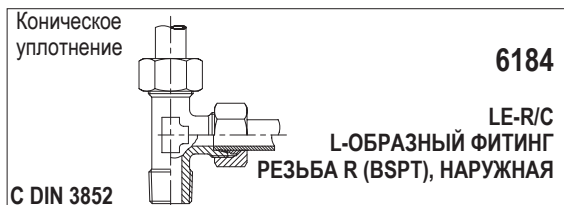

Код	Тип	Диам. трубы	Резьба
6184-04-02	LE 4 LL	4mm	R 1/8"
6184-05-02	LE 5 LL	5mm	R 1/8"
6184-06-02	LE 6 LL	6mm	R 1/8"
6184-08-02	LE 8 LL	8mm	R 1/8"

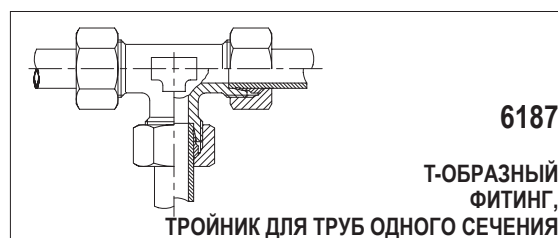

Код	Тип	Диам. трубы
6187-04-04	T 4 LL	4mm
6187-05-05	T 5 LL	5mm
6187-06-06	T 6 LL	6mm
6187-08-08	T 8 LL	8mm
6187-10-10	T10 LL	10mm
6187-12-12	T12 LL	12mm



Код	Тип	Диам. трубы	Резьба
6183-04-08	LE 4 LL	4mm	M8 x 1 k
6183-05-08	LE 5 LL	5mm	M8 x 1 k
6183-06-10	LE 6 LL	6mm	M10 x 1 k
6183-08-10	LE 8 LL	8mm	M10 x 1 k



Код	Тип	Диам. трубы
6188-04-04	K 4 LL	4mm
6188-06-06	K 6 LL	6mm
6188-08-08	K 8 LL	8mm

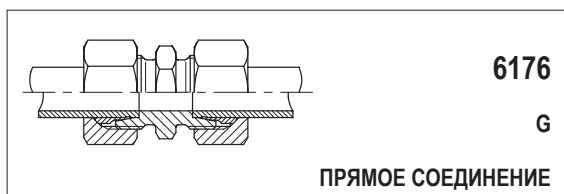

Код	Тип	Диам. трубы
6176-04-04	G 4 LL	4mm
6176-05-05	G 5 LL	5mm
6176-06-06	G 6 LL	6mm
6176-08-08	G 8 LL	8mm
6176-10-10	G 10 LL	10mm
6176-12-12	G 12 LL	12mm

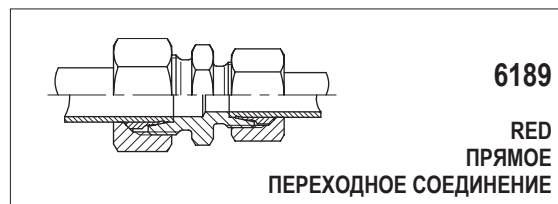

Код	Тип	Диам. трубы
6189-06-04	RED 6 / 4 LL	6 - 4mm
6189-08-04	RED 8 / 4 LL	8 - 4mm
6189-08-06	RED 8 / 6 LL	8 - 6mm



Код	Тип	Диам. трубы
6178-04-04	W 4 LL	4mm
6178-05-05	W 5 LL	5mm
6178-06-06	W 6 LL	6mm
6178-08-08	W 8 LL	8mm
6178-10-10	W 10 LL	10mm
6178-12-12	W 12 LL	12mm



6186

**WHO-G
БАНДЖО, УГЛОВОЙ
БОЛТОМ, РЕЗЬБА G,
И ЭЛАСТОМЕРНЫМ УПЛОТНЕНИЕМ**

Код	Тип	Диам. трубы	Резьба
6186-04-02	WHO 4 LL	4mm	G 1/8"
6186-05-02	WHO 5 LL	5mm	G 1/8"
6186-06-02	WHO 6 LL	6mm	G 1/8"
6186-08-02	WHO 8 LL	8mm	G 1/8"



6179

D

ВРЕЗНОЕ КОЛЬЦО, 2 КРОМКИ

Код	Тип	Диам. трубы
6179-00-04	D 4 LL	4mm
6179-00-05	D 5 LL	5mm
6179-00-06	D 6 LL	6mm
6179-00-08	D 8 LL	8mm



6185

**SWVE-M
БАНДЖО, УГЛОВОЙ С
БОЛТОМ, РЕЗЬБА M, И
УПЛОТНЕНИЕМ "МЕТАЛЛ К
МЕТАЛЛУ"**

Код	Тип	Диам. трубы	Резьба
6185-04-08	SWVE 4 LL	4mm	M8 x 1,0
6185-05-08	SWVE 6 LL	6mm	M8 x 1,0
6185-06-10	SWVE 6 LL	6mm	M10 x 1,0
6185-08-10	SWVE 8 LL	8mm	M10 x 1,0



6180

M

**ЗАТЯЖНАЯ ГАЙКА ДЛЯ
ФИТИНГОВ С ВРЕЗНЫМИ
КОЛЬЦАМИ**

Код	Тип	Диам. трубы	Резьба
6180-00-04	M 4 LL	4mm	M8 x 1,0
6180-00-05	M 5 LL	5mm	M10 x 1,0
6180-00-06	M 6 LL	6mm	M10 x 1,0
6180-00-08	M 8 LL	8mm	M12 x 1,0

ПРИМЕЧАНИЕ! Все фитинги с врезными кольцами могут также поставляться без гайки и врезного кольца.



Стальная
обрезиненная шайба

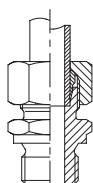

6002

GE-G

**РЕЗЬБА G (BSP), НАРУЖНАЯ, ДЛЯ
ФИТИНГА С УПЛОТНЕНИЕМ В ОПРАВЕ**

A DIN 3852-2

Врезная кромка

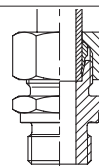

6003

GE-G

**РЕЗЬБА G (BSP), НАРУЖНАЯ, ДЛЯ
УПЛОТНЕНИЯ "МЕТАЛЛ К МЕТАЛЛУ"**

ISO 1179-4

Код	Тип	Диам. трубы	Резьба
6002-06-02	GE 6 L	6mm	G 1/8"
6002-10-04	GE 10 L	10mm	G 1/4"
6002-12-04	GE 12 L	12mm	G 1/4"
6002-12-06	GE 12 L	12mm	G 3/8"
6002-12-08	GE 12 L	12mm	G 1/2"
6002-15-06	GE 15 L	15mm	G 3/8"
6502-06-02	GE 6 S	6mm	G 1/8"
6502-06-04	GE 6 S	6mm	G 1/4"
6502-08-04	GE 8 S	8mm	G 1/4"
6502-10-06	GE 10 S	10mm	G 3/8"
6502-12-06	GE 12 S	12mm	G 3/8"
6502-16-08	GE 16 S	16mm	G 1/2"
6502-20-12	GE 20 S20mm	G	3/4"
6502-25-16	GE 25 S25mm	G	1"
6502-30-20	GE 30 S30mm	G	1 1/4"

Код	Тип	Диам. трубы	Резьба
6003-06-02	GE 6 L	6mm	G 1/8"
6003-06-04	GE 6 L	6mm	G 1/4"
6003-06-06	GE 6 L	6mm	G 3/8"
6003-08-02	GE 8 L	8mm	G 1/8"
6003-08-04	GE 8 L	8mm	G 1/4"
6003-08-06	GE 8 L	8mm	G 3/8"
6003-08-08	GE 8 L	8mm	G 1/2"
6003-10-04	GE 10 L	10mm	G 1/4"
6003-10-06	GE 10 L	10mm	G 3/8"
6003-10-08	GE 10 L	10mm	G 1/2"
6003-12-04	GE 12 L	12mm	G 1/4"
6003-12-06	GE 12 L	12mm	G 3/8"
6003-12-08	GE 12 L	12mm	G 1/2"
6003-15-06	GE 15 L	15mm	G 3/8"
6003-15-08	GE 15 L	15mm	G 1/2"
6003-15-12	GE 15 L	15mm	G 3/4"
6003-18-08	GE 18 L	18mm	G 1/2"
6003-18-12	GE 18 L	18mm	G 3/4"
6003-22-08	GE 22 L	22mm	G 1/2"
6003-22-12	GE 22 L	22mm	G 3/4"
6003-28-16	GE 28 L	28mm	G 1"
6003-35-20	GE 35 L	35mm	G 1 1/4"
6003-42-24	GE 42 L	42mm	G 1 1/2"
6503-06-04	GE 6 S	6mm	G 1/4"
6503-08-04	GE 8 S	8mm	G 1/4"
6503-10-06	GE 10 S	10mm	G 3/8"
6503-12-06	GE 12 S	12mm	G 3/8"
6503-12-08	GE 12 S	12mm	G 1/2"
6503-14-08	GE 14 S	14mm	G 1/2"
6503-16-08	GE 16 S	16mm	G 1/2"
6503-16-12	GE 16 S	16mm	G 3/4"
6503-20-08	GE 20 S	20mm	G 1/2"
6503-20-12	GE 20 S	20mm	G 3/4"
6503-25-16	GE 25 S	25mm	G 1"
6503-30-20	GE 30 S	30mm	G 1 1/4"
6503-38-20	GE 38 S	38mm	G 1 1/4"

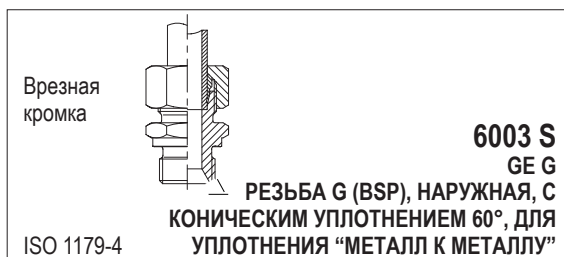

Код	Тип	Диам. трубы	Резьба
6003-08-04S	GE 8 L	8mm	G 1/4"
6003-10-04S	GE 10 L	10mm	G 1/4"
6003-10-06S	GE 10 L	10mm	G 3/8"
6003-10-08S	GE 10 L	10mm	G 1/2"
6003-12-04S	GE 12 L	12mm	G 1/4"
6003-12-06S	GE 12 L	12mm	G 3/8"
6003-12-08S	GE 12 L	12mm	G 1/2"
6003-15-06S	GE 15 L	15mm	G 3/8"
6003-15-08S	GE 15 L	15mm	G 1/2"
6003-18-08S	GE 18 L	18mm	G 1/2"
6003-22-12S	GE 22 L	22mm	G 3/4"
6003-28-16S	GE 28 L	28mm	G 1"
6003-35-20S	GE 35 L	35mm	G 1 1/4"
6003-42-24S	GE 42 L	42mm	G 1 1/2"
6503-08-04S	GE 8 S	8mm	G 1/4"
6503-10-06S	GE 10 S	10mm	G 3/8"
6503-12-06S	GE 12 S	12mm	G 3/8"
6503-14-08S	GE 14 S	14mm	G 1/2"
6503-16-08S	GE 16 S	16mm	G 1/2"
6503-20-08S	GE 20 S	20mm	G 1/2"
6503-20-12S	GE 20 S	20mm	G 3/4"
6503-25-12S	GE 25 S	25mm	G 3/4"
6503-25-16S	GE 25 S	25mm	G 1"
6503-30-12S	GE 30 S	30mm	G 3/4"
6503-30-16S	GE 30 S	30mm	G 1"
6503-30-20S	GE 30 S	30mm	G 1 1/4"
6503-38-24S	GE 38 S	38mm	G 1 1/2"

Код	Тип	Диам. трубы	Резьба
6003-06-03	GE 6 L корпус	6mm	G 1/8"
6003-08-05	GE 8 L корпус	8mm	G 1/4"
6003-08-07	GE 8 L корпус	8mm	G 3/8"
6003-10-05	GE 10 L корпус	10mm	G 1/4"
6003-10-07	GE 10 L корпус	10mm	G 3/8"
6003-10-09	GE 10 L корпус	10mm	G 1/2"
6003-12-05	GE 12 L корпус	12mm	G 1/4"
6003-12-07	GE 12 L корпус	12mm	G 3/8"
6003-12-09	GE 12 L корпус	12mm	G 1/2"
6003-15-07	GE 15 L корпус	15mm	G 3/8"
6003-15-09	GE 15 L корпус	15mm	G 1/2"
6003-15-13	GE 15 L корпус	15mm	G 3/4"
6003-18-09	GE 18 L корпус	18mm	G 1/2"
6003-18-13	GE 18 L корпус	18mm	G 3/4"
6003-22-09	GE 22 L корпус	22mm	G 1/2"
6003-22-13	GE 22 L корпус	22mm	G 3/4"
6003-28-17	GE 28 L корпус	28mm	G 1"
6003-35-21	GE 35 L корпус	35mm	G 1 1/4"
6003-42-25	GE 42 L корпус	42mm	G 1 1/2"
6503-06-05	GE 6 S корпус	6mm	G 1/4"
6503-08-05	GE 8 S корпус	8mm	G 1/4"
6503-10-07	GE 10 S корпус	10mm	G 3/8"
6503-12-07	GE 12 S корпус	12mm	G 3/8"
6503-12-09	GE 12 S корпус	12mm	G 1/2"
6503-14-09	GE 14 S корпус	14mm	G 1/2"
6503-16-09	GE 16 S корпус	16mm	G 1/2"
6503-16-13	GE 16 S корпус	16mm	G 3/4"
6503-20-09	GE 20 S корпус	20mm	G 1/2"
6503-20-13	GE 20 S корпус	20mm	G 3/4"
6503-25-17	GE 25 S корпус	25mm	G 1"
6503-30-21	GE 30 S корпус	30mm	G 1 1/4"
6503-38-21	GE 38 S корпус	38mm	G 1 1/4"

ПРИМЕЧАНИЕ! Все фитинги с врезными кольцами могут также поставляться без гайки и врезного кольца.



Врезная кромка

6006

GE-M

ISO 1179-4

КОРПУС С НАРУЖНОЙ РЕЗЬБОЙ М, ДЛЯ УПЛОТНЕНИЯ "МЕТАЛЛ К МЕТАЛЛУ"

Код	Тип	Диам. трубы	Резьба
6006-06-10	GE 6 L	6mm	M10 x 1,0
6006-08-12	GE 8 L	8mm	M12 x 1,5
6006-10-14	GE 10 L	10mm	M14 x 1,5
6006-10-16	GE 10 L	10mm	M16 x 1,5
6006-10-22	GE 10 L	10mm	M22 x 1,5
6006-12-14	GE 12 L	12mm	M14 x 1,5
6006-12-16	GE 12 L	12mm	M16 x 1,5
6006-15-18	GE 15 L	15mm	M18 x 1,5
6006-18-22	GE 18 L	18mm	M22 x 1,5
6006-22-26	GE 22 L	22mm	M26 x 1,5
6006-28-33	GE 28 L	28mm	M33 x 2,0
6006-42-48	GE 42 L	42mm	M48 x 2,0
6506-06-12	GE 6 S	6mm	M12 x 1,5
6506-08-14	GE 8 S	8mm	M14 x 1,5
6506-10-16	GE 10 S	10mm	M16 x 1,5
6506-12-18	GE 12 S	12mm	M18 x 1,5
6506-14-20	GE 14 S	14mm	M20 x 1,5
6506-16-22	GE 16 S	16mm	M22 x 1,5
6506-20-27	GE 20 S	20mm	M27 x 2,0
6506-25-33	GE 25 S	25mm	M33 x 2,0
6506-30-42	GE 30 S	30mm	M42 x 2,0
6506-38-48	GE 38 S	38mm	M48 x 2,0

Врезная кромка

6006

GE-MB КОРПУС

B DIN 3852

КОРПУС С НАРУЖНОЙ РЕЗЬБОЙ М, ДЛЯ УПЛОТНЕНИЯ "МЕТАЛЛ К МЕТАЛЛУ"

Код	Тип	Диам. трубы	Резьба
6006-06-11	GE 6 L корпус	6mm	M10 x 1,0
6006-08-13	GE 8 L корпус	8mm	M12 x 1,5
6006-10-15	GE 10 L корпус	10mm	M14 x 1,5
6006-10-23	GE 10 L корпус	10mm	M22 x 1,5
6006-12-17	GE 12 L корпус	12mm	M16 x 1,5
6006-18-23	GE 18 L корпус	18mm	M22 x 1,5
6006-22-27	GE 22 L корпус	22mm	M26 x 1,5
6506-12-19	GE 12 S корпус	12mm	M18 x 1,5
6506-16-23	GE 16 S корпус	16mm	M22 x 1,5
6506-30-43	GE 30 S корпус	30mm	M42 x 2,0

Коническое уплотнение

6007

ANSI/ASME B1.20.1-1983

GE-NPT ТРУБНАЯ РЕЗЬБА БЕЗ ПРОКЛАДОЧНЫХ УПЛОТНЕНИЙ (NPT), НАРУЖНАЯ

Код	Тип	Диам. трубы	Резьба
6007-06-02	GE 6 L	6mm	1/8" -27 NPT
6007-06-04	GE 6 L	6mm	1/4" -18 NPT
6007-08-04	GE 8 L	8mm	1/4" -18 NPT
6007-10-04	GE 10 L	10mm	1/4" -18 NPT
6007-12-04	GE 12 L	12mm	1/4" -18 NPT
6007-12-06	GE 12 L	12mm	3/8" -18 NPT
6007-12-08	GE 12 L	12mm	1/2" -14 NPT
6007-15-08	GE 15 L	15mm	1/2" -14 NPT
6007-18-08	GE 18 L	18mm	1/2" -14 NPT
6007-22-12	GE 22 L	22mm	3/4" -14 NPT
6007-28-16	GE 28 L	28mm	1" -11½ NPT
6007-35-20	GE 35 L	35mm	1 1/4" -11½ NPT
6007-42-24	GE 42 L	42mm	1 1/2" -11½ NPT
6507-06-04	GE 6 S	6mm	1/4" -18 NPT
6507-08-04	GE 8 S	8mm	1/4" -18 NPT
6507-10-04	GE 10 S	10mm	1/4" -18 NPT
6507-10-06	GE 10 S	10mm	3/8" -18 NPT
6507-12-04	GE 12 S	12mm	1/4" -18 NPT
6507-12-06	GE 12 S	12mm	3/8" -18 NPT
6507-14-08	GE 14 S	14mm	1/2" -14 NPT
6507-16-08	GE 16 S	16mm	1/2" -14 NPT
6507-20-12	GE 20 S	20mm	3/4" -14 NPT
6507-25-16	GE 25 S	25mm	1" -11½ NPT
6507-30-20	GE 30 S	30mm	1 1/4" -11½ NPT
6507-38-24	GE 38 S	38mm	1 1/2" -11½ NPT



Кольцевое уплотнение

6008

GE-UNF
УНИФИЦИРОВАННАЯ РЕЗЬБА,
НАРУЖНАЯ, С КОЛЬЦЕВЫМ
УПЛОТНЕНИЕМ

UN-UNF SAE J514

Код	Тип	Диам. трубы	Резьба
6008-06-07	GE 6 L	6mm	7/16" -20 UNF
6008-08-07	GE 8 L	8mm	7/16" -20 UNF
6008-08-08	GE 8 L	8mm	1/2" -20 UNF
6008-10-07	GE 10 L	10mm	7/16" -20 UNF
6008-10-09	GE 10 L	10mm	9/16" -18 UNF
6008-12-09	GE 12 L	12mm	9/16" -18 UNF
6008-12-12	GE 12 L	12mm	3/4" -16 UNF
6008-12-14	GE 12 L	12mm	7/8" -14 UNF
6008-15-12	GE 15 L	15mm	3/4" -16 UNF
6008-18-12	GE 18 L	18mm	3/4" -16 UNF
6008-18-14	GE 18 L	18mm	7/8" -14 UNF
6008-22-14	GE 22 L	22mm	7/8" -14 UNF
6008-22-17	GE 22 L	22mm	1 1/16" -12 UN
6008-22-21	GE 22 L	22mm	1 5/16" -12 UN
6008-28-17	GE 28 L	28mm	1 1/16" -12 UN
6008-28-21	GE 28 L	28mm	1 5/16" -12 UN
6008-35-21	GE 35 L	35mm	1 5/16" -12 UN
6008-35-26	GE 35 L	35mm	1 5/8" -12 UN
6008-42-26	GE 42 L	42mm	1 5/8" -12 UN
6508-08-07	GE 8 S	8mm	7/16" -20 UNF
6508-08-08	GE 8 S	8mm	1/2" -20 UNF
6508-10-09	GE 10 S	10mm	9/16" -18 UNF
6508-12-09	GE 12 S	12mm	9/16" -18 UNF
6508-12-12	GE 12 S	12mm	3/4" -16 UNF
6508-16-12	GE 16 S	16mm	3/4" -16 UNF
6508-16-14	GE 16 S	16mm	7/8" -14 UNF
6508-20-12	GE 20 S	16mm	3/4" -16 UNF
6508-20-14	GE 20 S	20mm	7/8" -14 UNF
6508-20-17	GE 20 S	20mm	1 1/16" -12 UN
6508-20-21	GE 20 S	20mm	1 5/16" -12 UN
6508-25-17	GE 25 S	25mm	1 1/16" -12 UN
6508-25-21	GE 25 S	25mm	1 5/16" -12 UN
6508-30-21	GE 30 S	30mm	1 5/16" -12 UN
6508-30-26	GE 30 S	30mm	1 5/8" -12 UN
6508-38-26	GE 38 S	38mm	1 5/8" -12 UN
6508-38-30	GE 38 S	38mm	1 7/8" -12 UN



Уплотнение ED

6009

GE-G/ED РЕЗЬБА G (BSP), НАРУЖНАЯ
С ЭЛАСТОМЕРНЫМ УПЛОТНЕНИЕМ

Код	Тип	Диам. трубы	Резьба
6009-06-02	GE 6 L	6mm	G 1/8"
6009-08-04	GE 8 L	8mm	G 1/4"
6009-08-06	GE 8 L	8mm	G 3/8"
6009-10-04	GE 10 L	10mm	G 1/4"
6009-10-08	GE 10 L	10mm	G 1/2"
6009-12-04	GE 12 L	12mm	G 1/4"
6009-12-06	GE 12 L	12mm	G 3/8"
6009-12-08	GE 12 L	12mm	G 1/2"
6009-15-08	GE 15 L	15mm	G 1/2"
6009-18-08	GE 18 L	18mm	G 1/2"
6009-18-12	GE 18 L	18mm	G 3/4"
6009-22-12	GE 22 L	22mm	G 3/4"
6009-28-16	GE 28 L	28mm	G 1"
6009-35-20	GE 35 L	35mm	G1 1/4"
6009-42-24	GE 42 L	42mm	G1 1/2"
6509-06-04	GE 6 S	6mm	G 1/4"
6509-08-04	GE 8 S	8mm	G 1/4"
6509-10-06	GE 10 S	10mm	G 3/8"
6509-12-06	GE 12 S	12mm	G 3/8"
6509-14-08	GE 14 S	14mm	G 1/2"
6509-16-08	GE 16 S	16mm	G 1/2"
6509-16-12	GE 16 S	16mm	G 3/4"
6509-20-12	GE 20 S	20mm	G 3/4"
6509-25-16	GE 25 S	25mm	G 1"
6509-30-20	GE 30 S	30mm	G1 1/4"
6509-38-24	GE 38 S	38mm	G1 1/2"

ПРИМЕЧАНИЕ! Все фитинги с врезными кольцами могут также поставляться без гайки и врезного кольца.



Код	Тип	Диам. трубы	Резьба
6009-06-03	GE 6 L корпус	6mm	G 1/8"
6009-08-05	GE 8 L корпус	8mm	G 1/4"
6009-10-05	GE 10 L корпус	10mm	G 1/4"
6009-12-07	GE 12 L корпус	12mm	G 3/8"
6009-12-09	GE 12 L корпус	12mm	G 1/2"
6009-15-09	GE 15 L корпус	15mm	G 1/2"
6009-18-09	GE 18 L корпус	18mm	G 1/2"
6009-18-13	GE 18 L корпус	18mm	G 3/4"
6009-22-13	GE 22 L корпус	22mm	G 3/4"
6009-28-17	GE 28 L корпус	28mm	G 1"
6009-35-21	GE 35 L корпус	35mm	G 1/4"
6009-42-25	GE 42 L корпус	42mm	G 1 1/2"
6509-06-05	GE 6 S корпус	6mm	G 1/4"
6509-08-05	GE 8 S корпус	8mm	G 1/4"
6509-10-07	GE 10 S корпус	10mm	G 3/8"
6509-12-07	GE 12 S корпус	12mm	G 3/8"
6509-14-09	GE 14 S корпус	14mm	G 1/2"
6509-16-09	GE 16 S корпус	16mm	G 1/2"
6509-16-13	GE 16 S корпус	16mm	G 3/4"
6509-20-13	GE 20 S корпус	20mm	G 3/4"
6509-25-17	GE 25 S корпус	25mm	G 1"
6509-30-21	GE 30 S корпус	30mm	G 1 1/4"
6509-38-25	GE 38 S корпус	38mm	G 1 1/2"



Код	Тип	Диам. трубы	Резьба
6010-06-10	GE 6 L	6mm	M 10 x 1,0
6010-08-12	GE 8 L	8mm	M 12 x 1,5
6010-10-12	GE 10 L	10mm	M 12 x 1,5
6010-10-14	GE 10 L	10mm	M 14 x 1,5
6010-12-16	GE 12 L	12mm	M 16 x 1,5
6010-15-18	GE 15 L	15mm	M 18 x 1,5
6010-15-22	GE 15 L	15mm	M 22 x 1,5
6010-18-22	GE 18 L	18mm	M 22 x 1,5
6010-22-26	GE 22 L	22mm	M 26 x 1,5
6010-28-33	GE 28 L	28mm	M 33 x 2,0
6010-35-42	GE 35 L	35mm	M 42 x 2,0
6010-42-48	GE 42 L	42mm	M 48 x 2,0
6510-06-12	GE 6 S	6mm	M 12 x 1,5
6510-08-14	GE 8 S	8mm	M 14 x 1,5
6510-10-16	GE 10 S	10mm	M 16 x 1,5
6510-12-18	GE 12 S	12mm	M 18 x 1,5
6510-14-20	GE 14 S	14mm	M 20 x 1,5
6510-16-22	GE 16 S	16mm	M 22 x 1,5
6510-20-27	GE 20 S	20mm	M 27 x 2,0
6510-25-33	GE 25 S	25mm	M 33 x 2,0
6510-30-42	GE 30 S	30mm	M 42 x 2,0
6510-38-48	GE 38 S	38mm	M 48 x 2,0



Код	Тип	Диам. трубы	Резьба
6010-06-11	GE 6 L корпус	6mm	M10 x 1,0
6010-08-13	GE 8 L корпус	8mm	M12 x 1,5
6010-10-15	GE 10 L корпус	10mm	M14 x 1,5
6010-12-17	GE 12 L корпус	12mm	M16 x 1,5
6010-15-19	GE 15 L корпус	15mm	M18 x 1,5
6010-18-23	GE 18 L корпус	18mm	M22 x 1,5
6010-22-27	GE 22 L корпус	22mm	M26 x 1,5
6010-35-43	GE 35 L корпус	35mm	M42 x 2,0
6010-42-49	GE 42 L корпус	42mm	M48 x 2,0
6510-06-13	GE 6 S корпус	6mm	M12 x 1,5
6510-08-15	GE 8 S корпус	8mm	M14 x 1,5
6510-10-17	GE 10 S корпус	10mm	M16 x 1,5
6510-12-19	GE 12 S корпус	12mm	M18 x 1,5
6510-14-21	GE 14 S корпус	14mm	M20 x 1,5
6510-16-23	GE 16 S корпус	16mm	M22 x 1,5
6510-20-28	GE 20 S корпус	20mm	M27 x 2,0
6510-25-34	GE 25 S корпус	25mm	M33 x 2,0
6510-30-43	GE 30 S корпус	30mm	M42 x 2,0
6510-38-49	GE 38 S корпус	38mm	M48 x 2,0

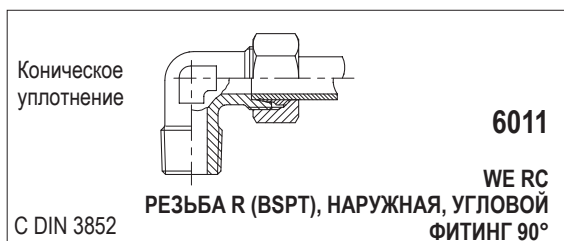

Код	Тип	Диам. трубы	Резьба
6011-06-02	WE 6 L	6mm	R 1/8"
6011-06-04	WE 6 L	6mm	R 1/4"
6011-08-04	WE 8 L	8mm	R 1/4"
6011-08-06	WE 8 L	8mm	R 3/8"
6011-10-04	WE 10 L	10mm	R 1/4"
6011-10-06	WE 10 L	10mm	R 3/8"
6011-12-06	WE 12 L	12mm	R 3/8"
6011-12-08	WE 12 L	12mm	R 1/2"
6011-15-08	WE 15 L	15mm	R 1/2"
6011-18-08	WE 18 L	18mm	R 1/2"
6511-06-04	WE 6 S	6mm	R 1/4"
6511-08-04	WE 8 S	8mm	R 1/4"
6511-10-06	WE 10 S	10mm	R 3/8"
6511-12-06	WE 12 S	12mm	R 3/8"
6511-14-08	WE 14 S	14mm	R 1/2"
6511-16-08	WE 16 S	16mm	R 1/2"



Код	Тип	Диам. трубы	Резьба
6013-22-12	WE 22 L	22mm	G 3/4"
6013-28-16	WE 28 L	28mm	G 1"
6013-35-20	WE 35 L	35mm	G 1 1/4"
6013-42-24	WE 42 L	42mm	G 1 1/2"
6513-20-12	WE 20 S	20mm	G 3/4"
6513-25-16	WE 25 S	25mm	G 1"
6513-30-20	WE 30 S	30mm	G 1 1/4"
6513-38-24	WE 38 S	38mm	G 1 1/2"



Код	Тип	Диам. трубы	Резьба
6014-06-10	WE 6 L	6mm	M10 x 1,0
6014-08-12	WE 8 L	8mm	M12 x 1,5
6014-10-14	WE 10 L	10mm	M14 x 1,5
6014-12-16	WE 12 L	12mm	M16 x 1,5
6014-15-18	WE 15 L	15mm	M18 x 1,5
6014-18-22	WE 18 L	18mm	M22 x 1,5
6514-06-12	WE 6 S	6mm	M12 x 1,5
6514-08-14	WE 8 S	8mm	M14 x 1,5
6514-10-16	WE 10 S	10mm	M16 x 1,5
6514-12-18	WE 12 S	12mm	M18 x 1,5
6514-14-20	WE 14 S	14mm	M20 x 1,5
6514-16-22	WE 16 S	16mm	M22 x 1,5



Код	Тип	Диам. трубы	Резьба
6016-22-26	WE 22 L	22mm	M26 x 1,5
6016-28-33	WE 28 L	28mm	M33 x 2,0
6016-35-42	WE 35 L	35mm	M42 x 2,0
6016-42-48	WE 42 L	42mm	M48 x 2,0
6516-20-27	WE 20 S	20mm	M27 x 2,0
6516-25-33	WE 25 S	25mm	M33 x 2,0
6516-30-42	WE 30 S	30mm	M42 x 2,0
6516-38-48	WE 38 S	38mm	M48 x 2,0

ПРИМЕЧАНИЕ! Все фитинги с врезными кольцами могут также поставляться без гайки и врезного кольца.



Код	Тип	Диам. трубы	Резьба
6017-06-02	WE 6 L	6mm	1/8" -27 NPT
6017-08-04	WE 8 L	8mm	1/4" -18 NPT
6017-10-04	WE 10 L	10mm	1/4" -18 NPT
6017-12-06	WE 12 L	12mm	3/8" -18 NPT
6017-15-08	WE 15 L	15mm	1/2" -14 NPT
6017-18-08	WE 18 L	18mm	1/2" -14 NPT
6017-22-12	WE 22 L	22mm	3/4" -14 NPT
6017-28-16	WE 28 L	28mm	1" -11½ NPT
6017-35-20	WE 35 L	35mm	1 1/4" -11½ NPT
6017-42-24	WE 42 L	42mm	1 1/2" -11½ NPT
6517-06-04	WE 6 S	6mm	1/4" -18 NPT
6517-08-04	WE 8 S	8mm	1/4" -18 NPT
6517-10-06	WE 10 S	10mm	3/8" -18 NPT
6517-12-06	WE 12 S	12mm	3/8" -18 NPT
6517-14-08	WE 14 S	14mm	1/2" -14 NPT
6517-16-08	WE 16 S	16mm	1/2" -14 NPT
6517-20-12	WE 20 S	20mm	3/4" - NPT
6517-25-16	WE 25 S	25mm	1" -11½ NPT
6517-30-20	WE 30 S	30mm	1 1/4" -11½ NPT

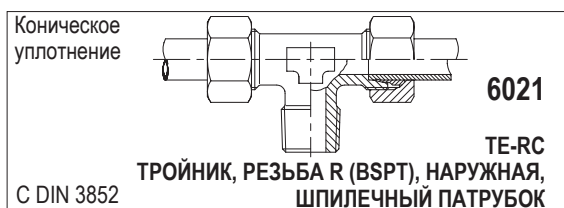

Код	Тип	Диам. трубы	Резьба
6021-06-02	TE 6 L	6mm	R 1/8"
6021-08-04	TE 8 L	8mm	R 1/4"
6021-10-04	TE 10 L	10mm	R 1/4"
6021-12-06	TE 12 L	12mm	R 3/8"
6021-15-08	TE 15 L	15mm	R 1/2"
6021-18-08	TE 18 L	18mm	R 1/2"
6021-22-12	TE 22 L	22mm	R 3/4"
6021-28-16	TE 28 L	28mm	R 1"
6021-35-20	TE 35 L	35mm	R 1 1/4"
6021-42-24	TE 42 L	42mm	R 1 1/2"
6521-06-04	TE 6 S	6mm	R 1/4"
6521-08-04	TE 8 S	8mm	R 1/4"
6521-10-06	TE 10 S	10mm	R 3/8"
6521-12-06	TE 12 S	12mm	R 3/8"
6521-14-08	TE 14 S	14mm	R 1/2"
6521-16-08	TE 16 S	16mm	R 1/2"
6521-20-12	TE 20 S	20mm	R 3/4"
6521-25-16	TE 25 S	25mm	R 1"
6521-30-20	TE 30 S	30mm	R 1 1/4"
6521-38-24	TE 38 S	38mm	R 1 1/2"



Код	Тип	Диам. трубы	Резьба
6023-22-12	TE 22 L	22mm	G 3/4"
6023-28-16	TE 28 L	28mm	G 1"
6023-35-20	TE 35 L	35mm	G 1 1/4"
6023-42-24	TE 42 L	42mm	G 1 1/2"
6523-20-12	TE 20 S	20mm	G 3/4"
6523-25-16	TE 25 S	25mm	G 1"
6523-30-20	TE 30 S	30mm	G 1 1/4"
6523-38-24	TE 38 S	38mm	G 1 1/2"

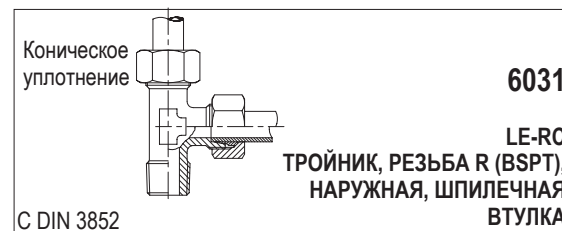

Код	Тип	Диам. трубы	Резьба
6031-06-02	LE 6 L	6mm	R 1/8"
6031-08-04	LE 8 L	8mm	R 1/4"
6031-10-04	LE 10 L	10mm	R 1/4"
6031-12-06	LE 12 L	12mm	R 3/8"
6031-15-08	LE 15 L	15mm	R 1/2"
6031-18-08	LE 18 L	18mm	R 1/2"
6031-22-12	LE 22 L	22mm	R 3/4"
6031-28-16	LE 28 L	28mm	R 1"
6031-35-20	LE 35 L	35mm	R 1 1/4"
6031-42-24	LE 42 L	42mm	R 1 2/4"
6531-06-04	LE 6 S	6mm	R 1/4"
6531-08-04	LE 8 S	8mm	R 1/4"
6531-10-06	LE 10 S	10mm	R 3/8"
6531-12-06	LE 12 S	12mm	R 3/8"
6531-14-08	LE 14 S	14mm	R 1/2"
6531-16-08	LE 16 S	16mm	R 1/2"
6531-20-12	LE 20 S	20mm	R 3/4"
6531-25-16	LE 25 S	25mm	R 1"
6531-30-20	LE 30 S	30mm	R 1 1/4"
6531-38-24	LE 38 S	38mm	R 1 1/2"

Другие резьбы имеются в наличии по запросу!



Код	Тип	Диам. трубы	Резьба
6033-22-12	LE 22 L	22mm	G 3/4"
6033-28-16	LE 28 L	28mm	G 1"
6033-35-20	LE 35 L	35mm	G 1 1/4"
6533-20-12	LE 20 S	20mm	G 3/4"
6533-25-16	LE 25 S	25mm	G 1"
6533-30-20	LE 30 S	30mm	G 1 1/4"
6533-38-24	LE 38 S	38mm	G 1 1/2"

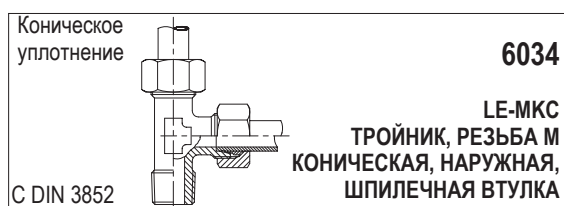

Код	Тип	Диам. трубы	Резьба
6034-06-10	LE 6 L	6mm	M10 x 1,0 k
6034-08-12	LE 8 L	8mm	M12 x 1,5 k
6034-10-14	LE 10 L	10mm	M14 x 1,5 k
6034-12-16	LE 12 L	12mm	M16 x 1,5 k
6034-15-18	LE 15 L	15mm	M18 x 1,5 k
6034-18-22	LE 18 L	18mm	M22 x 1,5 k



Код	Тип	Диам. трубы	Резьба
6036-22-26	LE 22 L	22mm	M26 x 1,5
6036-28-33	LE 28 L	28mm	M33 x 2,0
6036-35-42	LE 35 L	35mm	M42 x 2,0
6036-42-48	LE 42 L	42mm	M48 x 2,0



Код	Тип	Диам. трубы	Резьба
6035-06-06	DKLO 6 x DKLO 6	6	6mm
6035-08-08	DKLO 8 x DKLO 8	8	8mm
6035-10-10	DKLO 10 x DKLO 10	10	10mm
6035-12-12	DKLO 12 x DKLO 12	12	12mm
6035-15-15	DKLO 15 x DKLO 15	15	15mm
6035-18-18	DKLO 18 x DKLO 18	18	18mm
6035-22-22	DKLO 22 x DKLO 22	22	22mm
6035-28-28	DKLO 28 x DKLO 28	28	28mm
6035-35-35	DKLO 35 x DKLO 35	35	35mm

6535-06-06	DKSO 6 x DKSO 6	6	6mm
6535-08-08	DKSO 8 x DKSO 8	8	8mm
6535-10-10	DKSO 10 x DKSO 10	10	10mm
6535-12-12	DKSO 12 x DKSO 12	12	12mm
6535-14-14	DKSO 14 x DKSO 14	14	14mm
6535-16-16	DKSO 16 x DKSO 16	16	16mm
6535-20-20	DKSO 20 x DKSO 20	20	20mm
6535-25-25	DKSO 25 x DKSO 25	25	25mm
6535-30-30	DKSO 30 x DKSO 30	30	30mm
6535-38-38	DKSO 38 x DKSO 38	38	38mm



Код	Тип	Диам. трубы
6235-10-12	DKLO 10 x DKSO 12	10mm - 12mm
6235-10-14	DKLO 10 x DKSO 14	10mm - 14mm
6235-12-14	DKLO 12 x DKSO 14	12mm - 14mm
6235-12-16	DKLO 12 x DKSO 16	12mm - 16mm
6235-15-16	DKLO 15 x DKSO 16	15mm - 16mm
6235-15-20	DKLO 15 x DKSO 20	15mm - 20mm
6235-18-20	DKLO 18 x DKSO 20	18mm - 20mm
6235-18-25	DKLO 18 x DKSO 25	18mm - 25mm

ПРИМЕЧАНИЕ! Все фитинги с врезными кольцами могут также поставляться без гайки и врезного кольца.

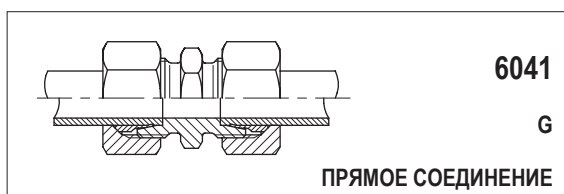

Код	Тип	Диам. трубы
6041-06-06	G 6 L	6mm
6041-08-08	G 8 L	8mm
6041-10-10	G 10 L	10mm
6041-12-12	G 12 L	12mm
6041-15-15	G 15 L	15mm
6041-18-18	G 18 L	18mm
6041-22-22	G 22 L	22mm
6041-28-28	G 28 L	28mm
6041-35-35	G 35 L	35mm
6041-42-42	G 42 L	42mm
6541-06-06	G 6 S	6mm
6541-08-08	G 8 S	8mm
6541-10-10	G 10 S	10mm
6541-12-12	G 12 S	12mm
6541-14-14	G 14 S	14mm
6541-16-16	G 16 S	16mm
6541-20-20	G 20 S	20mm
6541-25-25	G 25 S	25mm
6541-30-30	G 30 S	30mm
6541-38-38	G 38 S	38mm

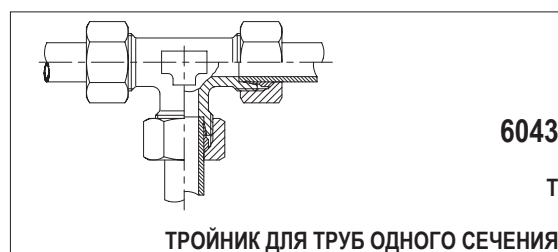

Код	Тип	Диам. трубы
6043-06-06	T 6 L	6mm
6043-08-08	T 8 L	8mm
6043-10-10	T 10 L	10mm
6043-12-12	T 12 L	12mm
6043-15-15	T 15 L	15mm
6043-18-18	T 18 L	18mm
6043-22-22	T 22 L	22mm
6043-28-28	T 28 L	28mm
6043-35-35	T 35 L	35mm
6043-42-42	T 42 L	42mm
6543-06-06	T 6 S	6mm
6543-08-08	T 8 S	8mm
6543-10-10	T 10 S	10mm
6543-12-12	T 12 S	12mm
6543-14-14	T 14 S	14mm
6543-16-16	T 16 S	16mm
6543-20-20	T 20 S	20mm
6543-25-25	T 25 S	25mm
6543-30-30	T 30 S	30mm
6543-38-38	T 38 S	38mm

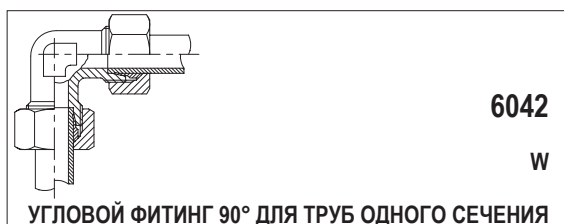

Код	Тип	Диам. трубы
6042-06-06	W 6 L	6mm
6042-08-08	W 8 L	8mm
6042-10-10	W 10 L	10mm
6042-12-12	W 12 L	12mm
6042-15-15	W 15 L	15mm
6042-18-18	W 18 L	18mm
6042-22-22	W 22 L	22mm
6042-28-28	W 28 L	28mm
6042-35-35	W 35 L	35mm
6042-42-42	W 42 L	42mm
6542-06-06	W 6 S	6mm
6542-08-08	W 8 S	8mm
6542-10-10	W 10 S	10mm
6542-12-12	W 12 S	12mm
6542-14-14	W 14 S	14mm
6542-16-16	W 16 S	16mm
6542-20-20	W 20 S	20mm
6542-25-25	W 25 S	25mm
6542-30-30	W 30 S	30mm
6542-38-38	W 38 S	38mm



Код	Тип	Диам. трубы
6044-06-06	К 6 L	6mm
6044-08-08	К 8 L	8mm
6044-10-10	К 10 L	10mm
6044-12-12	К 12 L	12mm
6044-15-15	К 15 L	15mm
6044-18-18	К 18 L	18mm
6044-22-22	К 22 L	22mm
6044-28-28	К 28 L	28mm
6044-35-35	К 35 L	35mm
6044-42-42	К 42 L	42mm
6544-06-06	К 6 S	6mm
6544-08-08	К 8 S	8mm
6544-10-10	К 10 S	10mm
6544-12-12	К 12 S	12mm
6544-14-14	К 14 S	14mm
6544-16-16	К 16 S	16mm
6544-20-20	К 20 S	20mm
6544-25-25	К 25 S	25mm
6544-30-30	К 30 S	30mm
6544-38-38	К 38 S	38mm



Код	Тип	Диам. трубы	Резьба
6046-06-06	WSV 6 L	6mm	M12 x 1,5
6046-08-08	WSV 8 L	8mm	M14 x 1,5
6046-10-10	WSV 10 L	10mm	M16 x 1,5
6046-12-12	WSV 12 L	12mm	M18 x 1,5
6046-15-15	WSV 15 L	15mm	M22 x 1,5
6046-18-18	WSV 18 L	18mm	M26 x 1,5
6046-22-22	WSV 22 L	22mm	M30 x 2,0
6046-28-28	WSV 28 L	28mm	M36 x 2,0
6046-35-35	WSV 35 L	35mm	M45 x 2,0
6046-42-42	WSV 42 L	42mm	M52 x 2,0
6546-06-06	WSV 6 S	6mm	M14 x 1,5
6546-08-08	WSV 8 S	8mm	M16 x 1,5
6546-10-10	WSV 10 S	10mm	M18 x 1,5
6546-12-12	WSV 12 S	12mm	M20 x 1,5
6546-14-14	WSV 14 S	14mm	M22 x 1,5
6546-16-16	WSV 16 S	16mm	M24 x 1,5
6546-20-20	WSV 20 S	20mm	M30 x 2,0
6546-25-25	WSV 25 S	25mm	M36 x 2,0
6546-30-30	WSV 30 S	30mm	M42 x 2,0
6546-38-38	WSV 38 S	38mm	M52 x 2,0

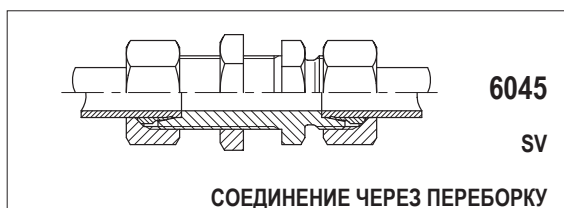

Код	Тип	Диам. трубы	Резьба
6045-06-06	SV 6 L	6mm	M12 x 1,5
6045-08-08	SV 8 L	8mm	M14 x 1,5
6045-10-10	SV 10 L	10mm	M16 x 1,5
6045-12-12	SV 12 L	12mm	M18 x 1,5
6045-15-15	SV 15 L	15mm	M22 x 1,5
6045-18-18	SV 18 L	18mm	M26 x 1,5
6045-22-22	SV 22 L	22mm	M30 x 2,0
6045-28-28	SV 28 L	28mm	M36 x 2,0
6045-35-35	SV 35 L	35mm	M45 x 2,0
6045-42-42	SV 42 L	42mm	M52 x 2,0
6545-06-06	SV 6 S	6mm	M14 x 1,5
6545-08-08	SV 8 S	8mm	M16 x 1,5
6545-10-10	SV 10 S	10mm	M18 x 1,5
6545-12-12	SV 12 S	12mm	M20 x 1,5
6545-14-14	SV 14 S	14mm	M22 x 1,5
6545-16-16	SV 16 S	16mm	M24 x 1,5
6545-20-20	SV 20 S	20mm	M30 x 2,0
6545-25-25	SV 25 S	25mm	M36 x 2,0
6545-30-30	SV 30 S	30mm	M42 x 2,0
6545-38-38	SV 38 S	38mm	M52 x 2,0

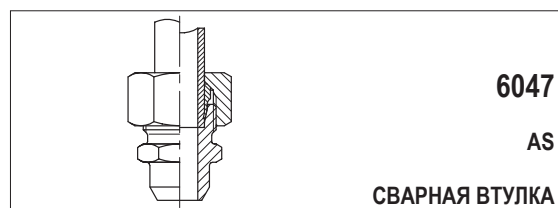

Код	Тип	Диам. трубы	Ø Резьба
6047-06-06	AS 6 L	6mm	10mm
6047-08-08	AS 8 L	8mm	12mm
6047-10-10	AS 10 L	10mm	14mm
6047-12-12	AS 12 L	12mm	16mm
6047-15-15	AS 15 L	15mm	19mm
6047-18-18	AS 18 L	18mm	22mm
6047-22-22	AS 22 L	22mm	27mm
6047-28-28	AS 28 L	28mm	32mm
6047-35-35	AS 35 L	35mm	40mm
6047-42-42	AS 42 L	42mm	46mm
6547-06-06	AS 6 S	6mm	11mm
6547-08-08	AS 8 S	8mm	13mm
6547-10-10	AS 10 S	10mm	15mm
6547-12-12	AS 12 S	12mm	17mm
6547-14-14	AS 14 S	14mm	19mm
6547-16-16	AS 16 S	16mm	21mm
6547-20-20	AS 20 S	20mm	26mm
6547-25-25	AS 25 S	25mm	31mm
6547-30-30	AS 30 S	30mm	36mm
6547-38-38	AS 38 S	38mm	44mm

ПРИМЕЧАНИЕ! Все фитинги с врезными кольцами могут также поставляться без гайки и врезного кольца.

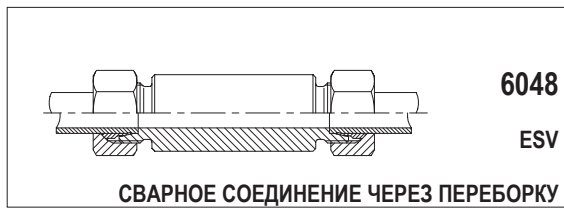

Код Тип Диаметр трубы Ø муфты обж.

6048-06-06	ESV 6 L	6mm	18mm
6048-08-08	ESV 8 L	8mm	20mm
6048-10-10	ESV 10 L	10mm	22mm
6048-12-12	ESV 12 L	12mm	25mm
6048-15-15	ESV 15 L	15mm	28mm
6048-18-18	ESV 18 L	18mm	32mm
6048-22-22	ESV 22 L	22mm	36mm
6048-28-28	ESV 28 L	28mm	40mm
6048-35-35	ESV 35 L	35mm	50mm
6048-42-42	ESV 42 L	42mm	60mm

6548-06-06	ESV 6 S	6mm	20mm
6548-08-08	ESV 8 S	8mm	22mm
6548-10-10	ESV 10 S	10mm	25mm
6548-12-12	ESV 12 S	12mm	28mm
6548-14-14	ESV 14 S	14mm	30mm
6548-16-16	ESV 16 S	16mm	35mm
6548-20-20	ESV 20 S	20mm	38mm
6548-25-25	ESV 25 S	25mm	45mm
6548-30-30	ESV 30 S	30mm	50mm
6548-38-38	ESV 38 S	38mm	60mm

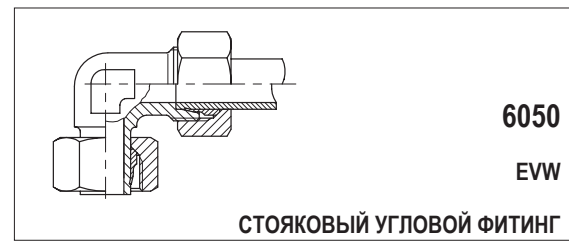

Код Тип Диаметр трубы

6050-06-06	EVW 6 L	6mm
6050-08-08	EVW 8 L	8mm
6050-10-10	EVW 10 L	10mm
6050-12-12	EVW 12 L	12mm
6050-15-15	EVW 15 L	15mm
6050-18-18	EVW 18 L	18mm
6050-22-22	EVW 22 L	22mm
6050-28-28	EVW 28 L	28mm
6050-35-35	EVW 35 L	35mm
6050-42-42	EVW 42 L	42mm

6550-06-06	EVW 6 S	6mm
6550-08-08	EVW 8 S	8mm
6550-10-10	EVW 10 S	10mm
6550-12-12	EVW 12 S	12mm
6550-14-14	EVW 14 S	14mm
6550-16-16	EVW 16 S	16mm
6550-20-20	EVW 20 S	20mm
6550-25-25	EVW 25 S	25mm
6550-30-30	EVW 30 S	30mm
6550-38-38	EVW 38 S	38mm

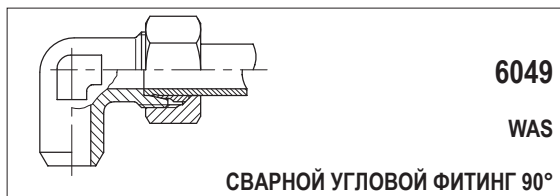

Код Тип Диаметр трубы

6049-06-06	WAS6 L6mm	10mm
6049-08-08	WAS8 L8mm	12mm
6049-10-10	WAS10 L10mm	14mm
6049-12-12	WAS12 L12mm	16mm
6049-15-15	WAS15 L15mm	19mm
6049-18-18	WAS18 L18mm	22mm
6049-22-22	WAS22 L22mm	27mm
6049-28-28	WAS28 L28mm	32mm
6049-35-35	WAS35 L35mm	40mm
6049-42-42	WAS42 L42mm	46mm
6549-06-06	WAS6 S6mm	11mm
6549-08-08	WAS8 S8mm	13mm
6549-10-10	WAS10 S10mm	15mm
6549-12-12	WAS12 S12mm	17mm
6549-14-14	WAS14 S14mm	19mm
6549-16-16	WAS16 S16mm	21mm
6549-20-20	WAS20 S20mm	26mm
6549-25-25	WAS25 S25mm	31mm
6549-30-30	WAS30 S30mm	36mm
6549-38-38	WAS38 S38mm	44mm



Код Тип Диаметр трубы

6051-06-06	EVWO 6 L	6mm
6051-08-08	EVWO 8 L	8mm
6051-10-10	EVWO 10 L	10mm
6051-12-12	EVWO 12 L	12mm
6051-15-15	EVWO 15 L	15mm
6051-18-18	EVWO 18 L	18mm
6051-22-22	EVWO 22 L	22mm
6051-28-28	EVWO 28 L	28mm
6051-35-35	EVWO 35 L	35mm
6051-42-42	EVWO 42 L	42mm

6551-06-06	EVWO 6 S	6mm
6551-08-08	EVWO 8 S	8mm
6551-10-10	EVWO 10 S	10mm
6551-12-12	EVWO 12 S	12mm
6551-14-14	EVWO 14 S	14mm
6551-16-16	EVWO 16 S	16mm
6551-20-20	EVWO 20 S	20mm
6551-25-25	EVWO 25 S	25mm
6551-30-30	EVWO 30 S	30mm
6551-38-38	EVWO 38 S	38mm

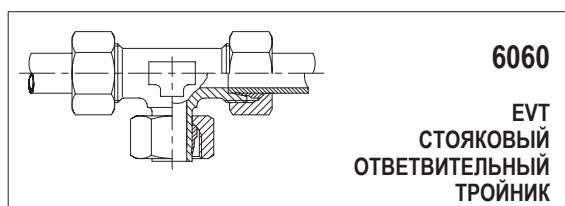

6060
EVT
СТОЯКОВЫЙ
ОТВЕТВИТЕЛЬНЫЙ
ТРОЙНИК

Код	Тип	Диам. трубы
6060-06-06	EVT 6 L	6mm
6060-08-08	EVT 8 L	8mm
6060-10-10	EVT 10 L	10mm
6060-12-12	EVT 12 L	12mm
6060-15-15	EVT 15 L	15mm
6060-18-18	EVT 18 L	18mm
6060-22-22	EVT 22 L	22mm
6060-28-28	EVT 28 L	28mm
6060-35-35	EVT 35 L	35mm
6060-42-42	EVT 42 L	42mm
6560-06-06	EVT 6 S	6mm
6560-08-08	EVT 8 S	8mm
6560-10-10	EVT 10 S	10mm
6560-12-12	EVT 12 S	12mm
6560-14-14	EVT 14 S	14mm
6560-16-16	EVT 16 S	16mm
6560-20-20	EVT 20 S	20mm
6560-25-25	EVT 25 S	25mm
6560-30-30	EVT 30 S	30mm
6560-38-38	EVT 38 S	38mm

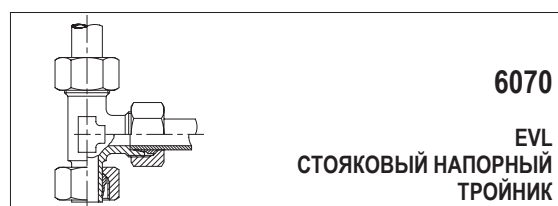

6070
EVL
СТОЯКОВЫЙ НАПОРНЫЙ
ТРОЙНИК

Код	Тип	Диам. трубы
6070-06-06	EVL 6 L	6mm
6070-08-08	EVL 8 L	8mm
6070-10-10	EVL 10 L	10mm
6070-12-12	EVL 12 L	12mm
6070-15-15	EVL 15 L	15mm
6070-18-18	EVL 18 L	18mm
6070-22-22	EVL 22 L	22mm
6070-28-28	EVL 28 L	28mm
6070-35-35	EVL 35 L	35mm
6070-42-42	EVL 42 L	42mm
6570-06-06	EVL 6 S	6mm
6570-08-08	EVL 8 S	8mm
6570-10-10	EVL 10 S	10mm
6570-12-12	EVL 12 S	12mm
6570-14-14	EVL 14 S	14mm
6570-16-16	EVL 16 S	16mm
6570-20-20	EVL 20 S	20mm
6570-25-25	EVL 25 S	25mm
6570-30-30	EVL 30 S	30mm
6570-38-38	EVL 38 S	38mm



6061
EVTO
ОТВЕТВИТЕЛЬНЫЙ ТРОЙНИК СО СТЯЖНОЙ
ГАЙКОЙ

Код	Тип	Диам. трубы
6061-06-06	EVTO 6 L	6mm
6061-08-08	EVTO 8 L	8mm
6061-10-10	EVTO 10 L	10mm
6061-12-12	EVTO 12 L	12mm
6061-15-15	EVTO 15 L	15mm
6061-18-18	EVTO 18 L	18mm
6061-22-22	EVTO 22 L	22mm
6061-28-28	EVTO 28 L	28mm
6061-35-35	EVTO 35 L	35mm
6061-42-42	EVTO 42 L	42mm
6561-06-06	EVTO 6 S	6mm
6561-08-08	EVTO 8 S	8mm
6561-10-10	EVTO 10 S	10mm
6561-12-12	EVTO 12 S	12mm
6561-14-14	EVTO 14 S	14mm
6561-16-16	EVTO 16 S	16mm
6561-20-20	EVTO 20 S	20mm
6561-25-25	EVTO 25 S	25mm
6561-30-30	EVTO 30 S	30mm
6561-38-38	EVTO 38 S	38mm



6071
EVLO
ОТВЕТВИТЕЛЬНЫЙ НАПОРНЫЙ
ТРОЙНИК СО СТЯЖНОЙ ГАЙКОЙ

Код	Тип	Диам. трубы
6071-06-06	EVLO 6 L	6mm
6071-08-08	EVLO 8 L	8mm
6071-10-10	EVLO 10 L	10mm
6071-12-12	EVLO 12 L	12mm
6071-15-15	EVLO 15 L	15mm
6071-18-18	EVLO 18 L	18mm
6071-22-22	EVLO 22 L	22mm
6071-28-28	EVLO 28 L	28mm
6071-35-35	EVLO 35 L	35mm
6071-42-42	EVLO 42 L	42mm
6571-06-06	EVLO 6 S	6mm
6571-08-08	EVLO 8 S	8mm
6571-10-10	EVLO 10 S	10mm
6571-12-12	EVLO 12 S	12mm
6571-14-14	EVLO 14 S	14mm
6571-16-16	EVLO 16 S	16mm
6571-20-20	EVLO 20 S	20mm
6571-25-25	EVLO 25 S	25mm
6571-30-30	EVLO 30 S	30mm
6571-38-38	EVLO 38 S	38mm

ПРИМЕЧАНИЕ! Все фитинги с врезными кольцами могут также поставляться без гайки и врезного кольца.



Код	Тип	Диам. трубы	Резьба
6083-06-02	EVGE 6 L	6mm	G 1/8"
6083-08-04	EVGE 8 L	8mm	G 1/4"
6083-10-04	EVGE 10 L	10mm	G 1/4"
6083-12-06	EVGE 12 L	12mm	G 3/8"
6083-15-08	EVGE 15 L	15mm	G 1/2"
6083-18-08	EVGE 18 L	18mm	G 1/2"
6083-22-12	EVGE 22 L	22mm	G 3/4"
6083-28-16	EVGE 28 L	28mm	G 1"
6083-35-20	EVGE 35 L	35mm	G 1 1/4"
6083-42-24	EVGE 42 L	42mm	G 1 1/2"
6583-06-04	EVGE 6 S	6mm	G 1/4"
6583-08-04	EVGE 8 S	8mm	G 1/4"
6583-10-06	EVGE 10 S	10mm	G 3/8"
6583-12-06	EVGE 12 S	12mm	G 3/8"
6583-14-08	EVGE 14 S	14mm	G 1/2"
6583-16-08	EVGE 16 S	16mm	G 1/2"
6583-20-12	EVGE 20 S	20mm	G 3/4"
6583-25-16	EVGE 25 S	25mm	G 1"
6583-30-20	EVGE 30 S	30mm	G 1 1/4"
6583-38-24	EVGE 38 S	38mm	G 1 1/2"

Код	Тип	Диам. трубы	Резьба
6089-06-02	EVGE 6 L	6mm	G 1/8"
6089-08-04	EVGE 8 L	8mm	G 1/4"
6089-10-04	EVGE 10 L	10mm	G 1/4"
6089-12-06	EVGE 12 L	12mm	G 3/8"
6089-15-08	EVGE 15 L	15mm	G 1/2"
6089-18-08	EVGE 18 L	18mm	G 1/2"
6089-22-12	EVGE 22 L	22mm	G 3/4"
6089-28-16	EVGE 28 L	28mm	G 1"
6089-35-20	EVGE 35 L	35mm	G 1 1/4"
6089-42-24	EVGE 42 L	42mm	G 1 1/2"
6589-06-04	EVGE 6 S	6mm	G 1/4"
6589-08-04	EVGE 8 S	8mm	G 1/4"
6589-10-06	EVGE 10 S	10mm	G 3/8"
6589-12-06	EVGE 12 S	12mm	G 3/8"
6589-14-08	EVGE 14 S	14mm	G 1/2"
6589-16-08	EVGE 16 S	16mm	G 1/2"
6589-20-12	EVGE 20 S	20mm	G 3/4"
6589-25-16	EVGE 25 S	25mm	G 1"
6589-30-20	EVGE 30 S	30mm	G 1 1/4"
6589-38-24	EVGE 38 S	38mm	G 1 1/2"

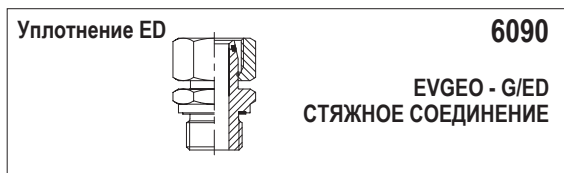

Код	Тип	Диам. трубы	Резьба
6090-06-02	EVGEO 6 L	6mm	G 1/8"
6090-08-04	EVGEO 8 L	8mm	G 1/4"
6090-10-04	EVGEO 10 L	10mm	G 1/4"
6090-12-06	EVGEO 12 L	12mm	G 3/8"
6090-15-08	EVGEO 15 L	15mm	G 1/2"
6090-18-08	EVGEO 18 L	18mm	G 1/2"
6090-22-12	EVGEO 22 L	22mm	G 3/4"
6090-28-16	EVGEO 28 L	28mm	G 1"
6090-35-20	EVGEO 35 L	35mm	G 1 1/4"
6090-42-24	EVGEO 42 L	42mm	G 1 1/2"
6590-06-04	EVGEO 6 S	6mm	G 1/4"
6590-08-04	EVGEO 8 S	8mm	G 1/4"
6590-10-06	EVGEO 10 S	10mm	G 3/8"
6590-12-06	EVGEO 12 S	12mm	G 3/8"
6590-14-08	EVGEO 14 S	14mm	G 1/2"
6590-16-08	EVGEO 16 S	16mm	G 1/2"
6590-20-12	EVGEO 20 S	20mm	G 3/4"
6590-25-16	EVGEO 25 S	25mm	G 1"
6590-30-20	EVGEO 30 S	30mm	G 1 1/4"
6590-38-24	EVGEO 38 S	38mm	G 1 1/2"

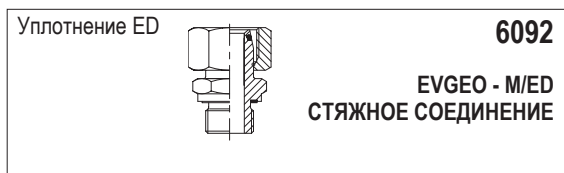

Код	Тип	Диам. трубы	Резьба
6092-06-10	EVGEO 6 L	6mm	M10 x 1,0
6092-08-12	EVGEO 8 L	8mm	M12 x 1,5
6092-10-14	EVGEO 10 L	10mm	M14 x 1,5
6092-12-16	EVGEO 12 L	12mm	M16 x 1,5
6092-15-18	EVGEO 15 L	15mm	M18 x 1,5
6092-18-22	EVGEO 18 L	18mm	M22 x 1,5
6092-22-26	EVGEO 22 L	22mm	M26 x 1,5
6092-28-33	EVGEO 28 L	28mm	M33 x 2,0
6092-35-42	EVGEO 35 L	35mm	M42 x 2,0
6092-42-48	EVGEO 42 L	42mm	M48 x 2,0
6592-06-12	EVGEO 6 S	6mm	M12 x 1,5
6592-08-14	EVGEO 8 S	8mm	M14 x 1,5
6592-10-16	EVGEO 10 S	10mm	M16 x 1,5
6592-12-18	EVGEO 12 S	12mm	M18 x 1,5
6592-14-20	EVGEO 14 S	14mm	M20 x 1,5
6592-16-22	EVGEO 16 S	16mm	M22 x 1,5
6592-20-27	EVGEO 20 S	20mm	M27 x 2,0
6592-25-33	EVGEO 25 S	25mm	M33 x 2,0
6592-30-42	EVGEO 30 S	30mm	M42 x 2,0
6592-38-48	EVGEO 38 S	38mm	M48 x 2,0

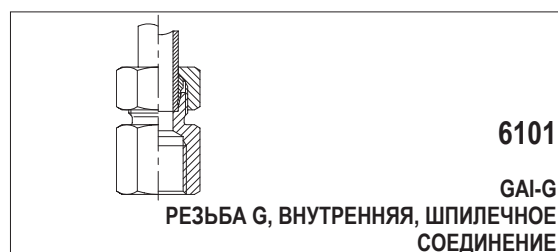

Код	Тип	Диам. трубы	Резьба
6101-06-02	GAI 6 L	6mm	G 1/8"
6101-08-04	GAI 8 L	8mm	G 1/4"
6101-08-06	GAI 8 L	8mm	G 3/8"
6101-10-04	GAI 10 L	10mm	G 1/4"
6101-12-06	GAI 12 L	12mm	G 3/8"
6101-12-08	GAI 12 L	12mm	G 1/2"
6101-15-08	GAI 15 L	15mm	G 1/2"
6101-18-08	GAI 18 L	18mm	G 1/2"
6101-22-12	GAI 22 L	22mm	G 3/4"
6101-28-16	GAI 28 L	28mm	G 1"
6101-35-20	GAI 35 L	35mm	G 1 1/4"
6101-42-24	GAI 42 L	42mm	G 1 1/2"
6601-06-04	GAI 6 S	6mm	G 1/4"
6601-08-04	GAI 8 S	8mm	G 1/4"
6601-10-06	GAI 10 S	10mm	G 3/8"
6601-12-06	GAI 12 S	12mm	G 3/8"
6601-14-08	GAI 14 S	14mm	G 1/2"
6601-16-08	GAI 16 S	16mm	G 1/2"
6601-20-12	GAI 20 S	20mm	G 3/4"
6601-25-16	GAI 25 S	25mm	G 1"
6601-30-20	GAI 30 S	30mm	G 1 1/4"
6601-38-24	GAI 38 S	38mm	G 1 1/2"

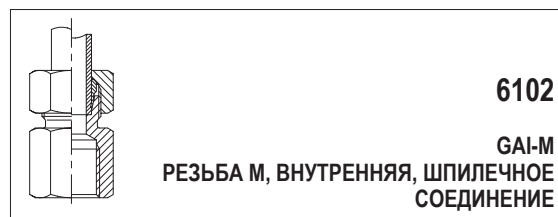

Код	Тип	Диам. трубы	Резьба
6102-06-10	GAI 6 L	6mm	M10 x 1,0
6102-08-12	GAI 8 L	8mm	M12 x 1,5
6102-10-14	GAI 10 L	10mm	M14 x 1,5
6102-12-16	GAI 12 L	12mm	M16 x 1,5
6102-15-18	GAI 15 L	15mm	M18 x 1,5
6102-18-22	GAI 18 L	18mm	M22 x 1,5
6102-22-26	GAI 22 L	22mm	M26 x 1,5
6602-06-12	GAI 6 S	6mm	M12 x 1,5
6602-08-14	GAI 8 S	8mm	M14 x 1,5
6602-10-16	GAI 10 S	10mm	M16 x 1,5
6602-12-18	GAI 12 S	12mm	M18 x 1,5
6602-14-20	GAI 14 S	14mm	M20 x 1,5
6602-16-22	GAI 16 S	16mm	M22 x 1,5
6602-20-27	GAI 20 S	20mm	M27 x 2,0

ПРИМЕЧАНИЕ! Все фитинги с врезными кольцами могут также поставляться без гайки и врезного кольца.



Код	Тип	Диам. трубы	Резьба
6103-06-04	MAV 6 L	6mm	G 1/4"
6103-08-04	MAV 8 L	8mm	G 1/4"
6103-10-04	MAV 10 L	10mm	G 1/4"
6103-12-04	MAV 12 L	12mm	G 1/4"
6603-06-08	MAV 6 S	6mm	G 1/2"
6603-08-04	MAV 8 S	8mm	G 1/4"
6603-08-08	MAV 8 S	8mm	G 1/2"
6603-10-08	MAV 10 S	10mm	G 1/2"
6603-12-08	MAV 12 S	12mm	G 1/2"

СВОБОДНЫЕ ВРЕЗНЫЕ КРОМКИ

Код	Тип	Размеры
6103-13-04	Cutting edge ring	1/4"
6603-13-08	Cutting edge ring	1/2"

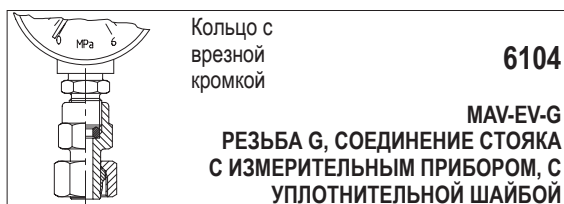

Код	Тип	Диам. трубы	Резьба
6104-06-04	MAV-EV 6 L	6mm	G 1/4"
6104-08-04	MAV-EV 8 L	8mm	G 1/4"
6104-10-04	MAV-EV 10 L	10mm	G 1/4"
6104-12-04	MAV-EV 12 L	12mm	G 1/4"
6604-06-08	MAV-EV 6 S	6mm	G 1/2"
6604-08-08	MAV-EV 8 S	8mm	G 1/2"
6604-10-08	MAV-EV 10 S	10mm	G 1/2"
6604-12-08	MAV-EV 12 S	12mm	G 1/2"



Код	Тип	Диам. трубы
6105-08-06	RED 8 / 6 L	8mm - 6mm
6105-10-06	RED 10 / 6 L	10mm - 6mm
6105-10-08	RED 10 / 8 L	10mm - 8mm
6105-12-06	RED 12 / 6 L	12mm - 6mm
6105-12-08	RED 12 / 8 L	12mm - 8mm
6105-12-10	RED 12 / 10 L	12mm -10mm
6105-15-06	RED 15 / 6 L	15mm - 6mm
6105-15-08	RED 15 / 8 L	15mm - 8mm
6105-15-10	RED 15 / 10 L	15mm -10mm
6105-15-12	RED 15 / 12 L	15mm -12mm
6105-18-08	RED 18 / 8 L	18mm - 8mm
6105-18-10	RED 18 / 10 L	18mm -10mm
6105-18-12	RED 18 / 12 L	18mm -12mm
6105-18-15	RED 18 / 15 L	18mm -15mm
6105-22-12	RED 22 / 12 L	22mm -12mm
6105-22-15	RED 22 / 15 L	22mm -15mm
6105-22-18	RED 22 / 18 L	22mm -18mm
6105-28-10	RED 28 / 10 L	28mm -10mm
6105-28-15	RED 28 / 15 L	28mm -15mm
6105-28-18	RED 28 / 18 L	28mm -18mm
6105-28-22	RED 28 / 22 L	28mm -22mm
6105-35-22	RED 35 / 22 L	35mm -22mm
6105-35-28	RED 35 / 28 L	35mm -28mm
6605-08-06	RED 8 / 6 S	8mm - 6mm
6605-10-06	RED 10 / 6 S	10mm - 6mm
6605-10-08	RED 10 / 8 S	10mm - 8mm
6605-12-06	RED 12 / 6 S	12mm - 6mm
6605-12-08	RED 12 / 8 S	12mm - 8mm
6605-12-10	RED 12 / 10 S	12mm -10mm
6605-14-10	RED 14 / 10 S	14mm -10 mm
6605-14-12	RED 14 / 12 S	14mm -12mm
6605-16-10	RED 16 / 10 S	16mm -10mm
6605-16-12	RED 16 / 12 S	16mm -12mm
6605-16-14	RED 16 / 14 S	16mm -14mm
6605-20-10	RED 20 / 10 S	20mm -10mm
6605-20-12	RED 20 / 12 S	20mm -12mm
6605-20-14	RED 20 / 14 S	20mm -14mm
6605-20-16	RED 20 / 16 S	20mm -16mm
6605-25-16	RED 25 / 16 S	25mm -16mm
6605-25-20	RED 25 / 20 S	25mm -20mm
6605-30-20	RED 30 / 20 S	30mm -20mm
6605-30-25	RED 30 / 25 S	30mm -25mm
6605-38-25	RED 38 / 25 S	38mm -25mm

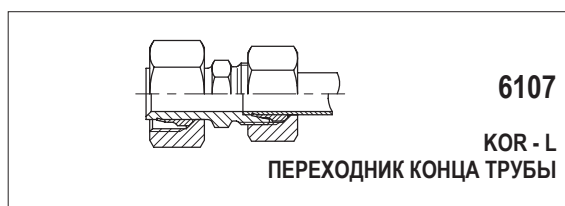

6107

KOR - L
ПЕРЕХОДНИК КОНЦА ТРУБЫ



6109

KORO-L
ПЕРЕХОДНИК КОНЦА ТРУБЫ С КОЛЬЦЕВЫМ
УПЛОТНЕНИЕМ

Код Тип Диам. трубы

6107-08-06	KOR 8 / 6 L	8mm - 6mm
6107-10-06	KOR 10 / 6 L	10mm - 6mm
6107-10-08	KOR 10 / 8 L	10mm - 8mm
6107-12-06	KOR 12 / 6 L	12mm - 6mm
6107-12-08	KOR 12 / 8 L	12mm - 8mm
6107-12-10	KOR 12 / 10 L	12mm - 10mm
6107-15-06	KOR 15 / 6 L	15mm - 6mm
6107-15-08	KOR 15 / 8 L	15mm - 8mm
6107-15-10	KOR 15 / 10 L	15mm - 10mm
6107-15-12	KOR 15 / 12 L	15mm - 12mm
6107-18-06	KOR 18 / 6 L	18mm - 6mm
6107-18-08	KOR 18 / 8 L	18mm - 8mm
6107-18-10	KOR 18 / 10 L	18mm - 10mm
6107-18-12	KOR 18 / 12 L	18mm - 12mm
6107-18-15	KOR 18 / 15 L	18mm - 15mm
6107-22-06	KOR 22 / 6 L	22mm - 6mm
6107-22-08	KOR 22 / 8 L	22mm - 8mm
6107-22-10	KOR 22 / 10 L	22mm - 10mm
6107-22-12	KOR 22 / 12 L	22mm - 12mm
6107-22-15	KOR 22 / 15 L	22mm - 15mm
6107-22-18	KOR 22 / 18 L	22mm - 18mm
6107-28-06	KOR 28 / 6 L	28mm - 6mm
6107-28-08	KOR 28 / 8 L	28mm - 8mm
6107-28-10	KOR 28 / 10 L	28mm - 10mm
6107-28-12	KOR 28 / 12 L	28mm - 12mm
6107-28-15	KOR 28 / 15 L	28mm - 15mm
6107-28-18	KOR 28 / 18 L	28mm - 18mm
6107-28-22	KOR 28 / 22 L	28mm - 22mm
6107-35-06	KOR 35 / 6 L	35mm - 6mm
6107-35-08	KOR 35 / 8 L	35mm - 8mm
6107-35-10	KOR 35 / 10 L	35mm - 10mm
6107-35-12	KOR 35 / 12 L	35mm - 12mm
6107-35-15	KOR 35 / 15 L	35mm - 15mm
6107-35-18	KOR 35 / 18 L	35mm - 18mm
6107-35-22	KOR 35 / 22 L	35mm - 22mm
6107-35-28	KOR 35 / 28 L	35mm - 28mm
6107-42-10	KOR 42 / 10 L	42mm - 10mm
6107-42-12	KOR 42 / 12 L	42mm - 12mm
6107-42-15	KOR 42 / 15 L	42mm - 15mm
6107-42-18	KOR 42 / 18 L	42mm - 18mm
6107-42-22	KOR 42 / 22 L	42mm - 22mm
6107-42-28	KOR 42 / 28 L	42mm - 28mm
6107-42-35	KOR 42 / 35 L	42mm - 35mm

Код Тип Диам. трубы

6109-08-06	KOR O 8 / 6 L	8mm - 6mm
6109-10-06	KOR O 10 / 6 L	10mm - 6mm
6109-10-08	KOR O 10 / 8 L	10mm - 8mm
6109-12-06	KOR O 12 / 6 L	12mm - 6mm
6109-12-08	KOR O 12 / 8 L	12mm - 8mm
6109-12-10	KOR O 12 / 10 L	12mm - 10mm
6109-15-06	KOR O 15 / 6 L	15mm - 6mm
6109-15-08	KOR O 15 / 8 L	15mm - 8mm
6109-15-10	KOR O 15 / 10 L	15mm - 10mm
6109-15-12	KOR O 15 / 12 L	15mm - 12mm
6109-18-06	KOR O 18 / 6 L	18mm - 6mm
6109-18-08	KOR O 18 / 8 L	18mm - 8mm
6109-18-10	KOR O 18 / 10 L	18mm - 10mm
6109-18-12	KOR O 18 / 12 L	18mm - 12mm
6109-18-15	KOR O 18 / 15 L	18mm - 15mm
6109-22-06	KOR O 22 / 6 L	22mm - 6mm
6109-22-08	KOR O 22 / 8 L	22mm - 8mm
6109-22-10	KOR O 22 / 10 L	22mm - 10mm
6109-22-12	KOR O 22 / 12 L	22mm - 12mm
6109-22-15	KOR O 22 / 15 L	22mm - 15mm
6109-22-18	KOR O 22 / 18 L	22mm - 18mm
6109-28-06	KOR O 28 / 6 L	28mm - 6mm
6109-28-08	KOR O 28 / 8 L	28mm - 8mm
6109-28-10	KOR O 28 / 10 L	28mm - 10mm
6109-28-12	KOR O 28 / 12 L	28mm - 12mm
6109-28-15	KOR O 28 / 15 L	28mm - 15mm
6109-28-18	KOR O 28 / 18 L	28mm - 18mm
6109-28-22	KOR O 28 / 22 L	28mm - 22mm
6109-35-06	KOR O 35 / 6 L	35mm - 6mm
6109-35-08	KOR O 35 / 8 L	35mm - 8mm
6109-35-10	KOR O 35 / 10 L	35mm - 10mm
6109-35-12	KOR O 35 / 12 L	35mm - 12mm
6109-35-15	KOR O 35 / 15 L	35mm - 15mm
6109-35-18	KOR O 35 / 18 L	35mm - 18mm
6109-35-22	KOR O 35 / 22 L	35mm - 22mm
6109-35-28	KOR O 35 / 28 L	35mm - 28mm
6109-42-06	KOR O 42 / 6 L	42mm - 6mm
6109-42-08	KOR O 42 / 8 L	42mm - 8mm
6109-42-10	KOR O 42 / 10 L	42mm - 10mm
6109-42-12	KOR O 42 / 12 L	42mm - 12mm
6109-42-15	KOR O 42 / 15 L	42mm - 15mm
6109-42-18	KOR O 42 / 18 L	42mm - 18mm
6109-42-22	KOR O 42 / 22 L	42mm - 22mm
6109-42-28	KOR O 42 / 28 L	42mm - 28mm
6109-42-35	KOR O 42 / 35 L	42mm - 35mm

ПРИМЕЧАНИЕ! Все фитинги с врезными кольцами могут также поставляться без гайки и врезного кольца.



Код Тип Диаметр трубы

6607-08-06	KOR 8 / 6 S	8mm - 6mm
6607-10-06	KOR 10 / 6 S	10mm - 6mm
6607-10-08	KOR 10 / 8 S	10mm - 8mm
6607-12-06	KOR 12 / 6 S	12mm - 6mm
6607-12-08	KOR 12 / 8 S	12mm - 8mm
6607-12-10	KOR 12 / 10 S	12mm -10mm
6607-14-06	KOR 14 / 6 S	14mm - 6mm
6607-14-08	KOR 14 / 8 S	14mm - 8mm
6607-14-10	KOR 14 / 10 S	14mm -10mm
6607-14-12	KOR 14 / 12 S	14mm -12mm
6607-16-06	KOR 16 / 6 S	16mm - 6mm
6607-16-08	KOR 16 / 8 S	16mm - 8mm
6607-16-10	KOR 16 / 10 S	16mm -10mm
6607-16-12	KOR 16 / 12 S	16mm -12mm
6607-16-14	KOR 16 / 14 S	16mm -14mm
6607-20-06	KOR 20 / 6 S	20mm - 6mm
6607-20-08	KOR 20 / 8 S	20mm - 8mm
6607-20-10	KOR 20 / 10 S	20mm -10mm
6607-20-12	KOR 20 / 12 S	20mm -12mm
6607-20-14	KOR 20 / 14 S	20mm -14mm
6607-20-16	KOR 20 / 16 S	20mm -16mm
6607-25-06	KOR 25 / 6 S	25mm - 6mm
6607-25-08	KOR 25 / 8 S	25mm - 8mm
6607-25-10	KOR 25 / 10 S	25mm -10mm
6607-25-12	KOR 25 / 12 S	25mm -12mm
6607-25-14	KOR 25 / 14 S	25mm -14mm
6607-25-16	KOR 25 / 16 S	25mm -16mm
6607-25-20	KOR 25 / 20 S	25mm -20mm
6607-30-06	KOR 30 / 6 S	30mm - 6mm
6607-30-08	KOR 30 / 8 S	30mm - 8mm
6607-30-10	KOR 30 / 10 S	30mm -10mm
6607-30-12	KOR 30 / 12 S	30mm -12mm
6607-30-14	KOR 30 / 14 S	30mm -14mm
6607-30-16	KOR 30 / 16 S	30mm -16mm
6607-30-20	KOR 30 / 20 S	30mm -20mm
6607-30-25	KOR 30 / 25 S	30mm -25mm
6607-38-06	KOR 38 / 6 S	38mm - 6mm
6607-38-08	KOR 38 / 8 S	38mm - 8mm
6607-38-10	KOR 38 / 10 S	38mm -10mm
6607-38-12	KOR 38 / 12 S	38mm -12mm
6607-38-14	KOR 38 / 14 S	38mm -14mm
6607-38-16	KOR 38 / 16 S	38mm -16mm
6607-38-20	KOR 38 / 20 S	38mm -20mm
6607-38-25	KOR 38 / 25 S	38mm -25mm
6607-38-30	KOR 38 / 30 S	38mm -30mm



Код Тип Диаметр трубы

6609-08-06	KOR O 8 / 6 S	8mm - 6mm
6609-10-06	KOR O 10 / 6 S	10mm - 6mm
6609-10-08	KOR O 10 / 8 S	10mm - 8mm
6609-12-06	KOR O 12 / 6 S	12mm - 6mm
6609-12-08	KOR O 12 / 8 S	12mm - 8mm
6609-12-10	KOR O 12 / 10 S	12mm -10mm
6609-14-06	KOR O 14 / 6 S	14mm - 6mm
6609-14-08	KOR O 14 / 8 S	14mm - 8mm
6609-14-10	KOR O 14 / 10 S	14mm -10mm
6609-14-12	KOR O 14 / 12 S	14mm -12mm
6609-16-06	KOR O 16 / 6 S	16mm - 6mm
6609-16-08	KOR O 16 / 8 S	16mm - 8mm
6609-16-10	KOR O 16 / 10 S	16mm -10mm
6609-16-12	KOR O 16 / 12 S	16mm -12mm
6609-16-14	KOR O 16 / 14 S	16mm -14mm
6609-20-06	KOR O 20 / 6 S	20mm - 6mm
6609-20-08	KOR O 20 / 8 S	20mm - 8mm
6609-20-10	KOR O 20 / 10 S	20mm -10mm
6609-20-12	KOR O 20 / 12 S	20mm -12mm
6609-20-14	KOR O 20 / 14 S	20mm -14mm
6609-20-16	KOR O 20 / 16 S	20mm -16mm
6609-25-06	KOR O 25 / 6 S	25mm - 6mm
6609-25-08	KOR O 25 / 8 S	25mm - 8mm
6609-25-10	KOR O 25 / 10 S	25mm -10mm
6609-25-12	KOR O 25 / 12 S	25mm -12mm
6609-25-14	KOR O 25 / 14 S	25mm -14mm
6609-25-16	KOR O 25 / 16 S	25mm -16mm
6609-25-20	KOR O 25 / 20 S	25mm -20mm
6609-30-08	KOR O 30 / 8 S	30mm - 8mm
6609-30-10	KOR O 30 / 10 S	30mm -10mm
6609-30-12	KOR O 30 / 12 S	30mm -12mm
6609-30-16	KOR O 30 / 16 S	30mm -16mm
6609-30-20	KOR O 30 / 20 S	30mm -20mm
6609-30-25	KOR O 30 / 25 S	30mm -25mm
6609-38-08	KOR O 38 / 8 S	38mm - 8mm
6609-38-12	KOR O 38 / 12 S	38mm -12mm
6609-38-16	KOR O 38 / 16 S	38mm -16mm
6609-38-20	KOR O 38 / 20 S	38mm -20mm
6609-38-25	KOR O 38 / 25 S	38mm -25mm
6609-38-30	KOR O 38 / 30 S	38mm -30mm

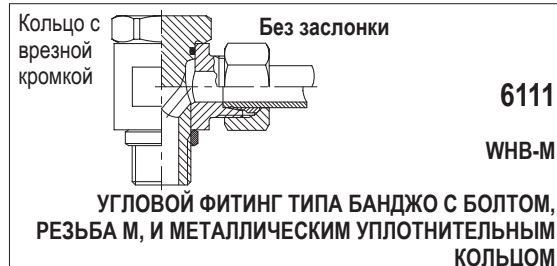

Код	Тип	Диам. трубы	Резьба
6110-06-02	WNB 6 L	6mm	G 1/8"
6110-08-04	WNB 8 L	8mm	G 1/4"
6110-10-04	WNB 10 L	10mm	G 1/4"
6110-12-06	WNB 12 L	12mm	G 3/8"
6110-15-08	WNB 15 L	15mm	G 1/2"
6110-18-08	WNB 18 L	18mm	G 1/2"
6110-22-12	WNB 22 L	22mm	G 3/4"
6110-28-16	WNB 28 L	28mm	G 1"
6110-35-20	WNB 35 L	35mm	G1 1/4"
6110-42-24	WNB 42 L	42mm	G1 1/2"

Код	Тип	Диам. трубы	Резьба
6111-06-10	WNB 6 L	6mm	M10 x 1,0
6111-08-12	WNB 8 L	8mm	M12 x 1,5
6111-10-14	WNB 10 L	10mm	M14 x 1,5
6111-12-16	WNB 12 L	12mm	M16 x 1,5
6111-15-18	WNB 15 L	15mm	M18 x 1,5
6111-18-22	WNB 18 L	18mm	M22 x 1,5
6111-22-26	WNB 22 L	22mm	M26 x 1,5
6111-28-33	WNB 28 L	28mm	M33 x 2,0
6111-35-42	WNB 35 L	35mm	M42 x 2,0
6111-42-48	WNB 42 L	42mm	M48 x 2,0

6610-06-04	WNB 6 S	6mm	G 1/4"
6610-08-04	WNB 8 S	8mm	G 1/4"
6610-10-06	WNB 10 S	10mm	G 3/8"
6610-12-06	WNB 12 S	12mm	G 3/8"
6610-14-08	WNB 14 S	14mm	G 1/2"
6610-16-08	WNB 16 S	16mm	G 1/2"
6610-20-12	WNB 20 S	20mm	G 3/4"
6610-25-16	WNB 25 S	25mm	G 1"
6610-30-20	WNB 30 S	30mm	G1 1/4"
6610-38-24	WNB 38 S	38mm	G1 1/2"

6611-06-12	WNB 6 S	6mm	M12 x 1,5
6611-08-14	WNB 8 S	8mm	M14 x 1,5
6611-10-16	WNB 10 S	10mm	M16 x 1,5
6611-12-18	WNB 12 S	12mm	M18 x 1,5
6611-14-20	WNB 14 S	14mm	M20 x 1,5
6611-16-22	WNB 16 S	16mm	M22 x 1,5
6611-20-27	WNB 20 S	20mm	M27 x 2,0
6611-25-33	WNB 25 S	25mm	M33 x 2,0
6611-30-42	WNB 30 S	30mm	M42 x 2,0
6611-38-48	WNB 38 S	38mm	M48 x 2,0



Код	Тип	Диам. трубы	Резьба
6118-06-02	WHO 6 L	6mm	G 1/8"
6118-08-04	WHO 8 L	8mm	G 1/4"
6118-10-04	WHO 10 L	10mm	G 1/4"
6118-12-06	WHO 12 L	12mm	G 3/8"
6118-15-08	WHO 15 L	15mm	G 1/2"
6118-18-08	WHO 18 L	18mm	G 1/2"
6118-22-12	WHO 22 L	22mm	G 3/4"
6618-06-04	WHO 6 S	6mm	G 1/4"
6618-08-04	WHO 8 S	8mm	G 1/4"
6618-10-06	WHO 10 S	10mm	G 3/8"
6618-12-06	WHO 12 S	12mm	G 3/8"
6618-14-08	WHO 14 S	14mm	G 1/2"
6618-16-08	WHO 16 S	16mm	G 1/2"
6618-20-12	WHO 20 S	20mm	G 3/4"
6618-25-16	WHO 25 S	25mm	G 1"
6618-30-20	WHO 30 S	30mm	G 1 1/4"

Код	Тип	Диам. трубы	Резьба
6119-06-10	WHO 6 L	6mm	M10 x 1,0
6119-08-12	WHO 8 L	8mm	M12 x 1,5
6119-10-14	WHO 10 L	10mm	M14 x 1,5
6119-12-16	WHO 12 L	12mm	M16 x 1,5
6119-15-18	WHO 15 L	15mm	M18 x 1,5
6119-18-22	WHO 18 L	18mm	M22 x 1,5
6119-22-26	WHO 22 L	22mm	M26 x 1,5
6619-06-12	WHO 6 S	6mm	M12 x 1,5
6619-08-14	WHO 8 S	8mm	M14 x 1,5
6619-10-16	WHO 10 S	10mm	M16 x 1,5
6619-12-18	WHO 12 S	12mm	M18 x 1,5
6619-14-20	WHO 14 S	14mm	M20 x 1,5
6619-16-22	WHO 16 S	16mm	M22 x 1,5
6619-20-27	WHO 20 S	20mm	M27 x 2,0

ПРИМЕЧАНИЕ! Все фитинги с врезными кольцами могут также поставляться без гайки и врезного кольца.



Кольцо с
врезной
кромкой

Без заслонки

6112

DSVW-G

УГЛОВОЙ ФИТИНГ ТИПА БАНДЖО С БОЛТОМ С ЗАПЛЕЧИКОМ, РЕЗЬБА G, ПРОБКой ДЛЯ ОТВЕРСТИЯ С ГОЛОВКОЙ ПОД КЛЮЧ И МЕТАЛЛИЧЕСКИМ УПЛОТНИТЕЛЬНЫМ КОЛЬЦОМ

Код	Тип	Диам. трубы	Резьба
6112-06-02	DSVW 6 L	6mm	G 1/8"
6112-08-04	DSVW 8 L	8mm	G 1/4"
6112-10-04	DSVW 10 L	10mm	G 1/4"
6112-12-06	DSVW 12 L	12mm	G 3/8"
6112-15-08	DSVW 15 L	15mm	G 1/2"
6112-18-08	DSVW 18 L	18mm	G 1/2"
6112-22-12	DSVW 22 L	22mm	G 3/4"
6112-28-16	DSVW 28 L	28mm	G 1"
6112-35-20	DSVW 35 L	35mm	G1 1/4"
6112-42-24	DSVW 42 L	42mm	G1 1/2"
6612-06-04	DSVW 6 S	6mm	G 1/4"
6612-08-04	DSVW 8 S	8mm	G 1/4"
6612-10-06	DSVW 10 S	10mm	G 3/8"
6612-12-06	DSVW 12 S	12mm	G 3/8"
6612-14-08	DSVW 14 S	14mm	G 1/2"
6612-16-08	DSVW 16 S	16mm	G 1/2"
6612-20-12	DSVW 20 S	20mm	G 3/4"
6612-25-16	DSVW 25 S	25mm	G 1"
6612-30-20	DSVW 30 S	30mm	G1 1/4"
6612-38-24	DSVW 38 S	38mm	G1 1/2"

Кольцо с
врезной
кромкой

Без заслонки

6114

DSVT-G

ТРОЙНИК ТИПА БАНДЖО С БОЛТОМ С ЗАПЛЕЧИКОМ, РЕЗЬБА G, ПРОБКой ДЛЯ ОТВЕРСТИЯ С ГОЛОВКОЙ ПОД КЛЮЧ И МЕТАЛЛИЧЕСКИМ УПЛОТНИТЕЛЬНЫМ КОЛЬЦОМ

Код	Тип	Диам. трубы	Резьба
6114-06-02	DSVT 6 L	6mm	G 1/8"
6114-08-04	DSVT 8 L	8mm	G 1/4"
6114-10-04	DSVT 10 L	10mm	G 1/4"
6114-12-06	DSVT 12 L	12mm	G 3/8"
6114-15-08	DSVT 15 L	15mm	G 1/2"
6114-18-08	DSVT 18 L	18mm	G 1/2"
6114-22-12	DSVT 22 L	22mm	G 3/4"
6114-28-16	DSVT 28 L	28mm	G 1"
6114-35-20	DSVT 35 L	35mm	G1 1/4"
6114-42-24	DSVT 42 L	42mm	G1 1/2"
6614-06-04	DSVT 6 S	6mm	G 1/4"
6614-08-04	DSVT 8 S	8mm	G 1/4"
6614-10-06	DSVT 10 S	10mm	G 3/8"
6614-12-06	DSVT 12 S	12mm	G 3/8"
6614-14-08	DSVT 14 S	14mm	G 1/2"
6614-16-08	DSVT 16 S	16mm	G 1/2"
6614-20-12	DSVT 20 S	20mm	G 3/4"
6614-25-16	DSVT 25 S	25mm	G 1"
6614-30-20	DSVT 30 S	30mm	G1 1/4"
6614-38-24	DSVT 38 S	38mm	G1 1/2"

Кольцо с
врезной
кромкой

Без заслонки

6116

WHBT-G

ТРОЙНИК ТИПА БАНДЖО С БОЛТОМ, РЕЗЬБА G, И МЕТАЛЛИЧЕСКИМ УПЛОТНИТЕЛЬНЫМ КОЛЬЦОМ

Код	Тип	Диам. трубы	Резьба
6116-06-02	WHBT 6 L	6mm	G 1/8"
6116-08-04	WHBT 8 L	8mm	G 1/4"
6116-10-04	WHBT 10 L	10mm	G 1/4"
6116-12-06	WHBT 12 L	12mm	G 3/8"
6116-15-08	WHBT 15 L	15mm	G 1/2"
6116-18-08	WHBT 18 L	18mm	G 1/2"
6116-22-12	WHBT 22 L	22mm	G 3/4"
6116-28-16	WHBT 28 L	28mm	G 1"
6116-35-20	WHBT 35 L	35mm	G1 1/4"
6116-42-24	WHBT 42 L	42mm	G1 1/2"
6616-06-04	WHBT 6 S	6mm	G 1/4"
6616-08-04	WHBT 8 S	8mm	G 1/4"
6616-10-06	WHBT 10 S	10mm	G 3/8"
6616-12-06	WHBT 12 S	12mm	G 3/8"
6616-14-08	WHBT 14 S	14mm	G 1/2"
6616-16-08	WHBT 16 S	16mm	G 1/2"
6616-20-12	WHBT 20 S	20mm	G 3/4"
6616-25-16	WHBT 25 S	25mm	G 1"
6616-30-20	WHBT 30 S	30mm	G1 1/4"
6616-38-24	WHBT 38 S	38mm	G1 1/2"

Кольцо с
врезной
кромкой

Без заслонки

6028

SWVE-G

ФИТИНГ ТИПА БАНДЖО С БОЛТОМ, РЕЗЬБА G, НАРУЖНАЯ

Код	Тип	Диам. трубы	Резьба
6028-06-02	SWVE 6 L	6mm	G 1/8"
6028-08-04	SWVE 8 L	8mm	G 1/4"
6028-10-04	SWVE 10 L	10mm	G 1/4"
6028-12-06	SWVE 12 L	12mm	G 3/8"
6028-15-08	SWVE 15 L	15mm	G 1/2"
6028-22-12	SWVE 22 L	22mm	G 3/4"



Другие невозвратные клапаны см. в главе 5:20



Код	Тип	Диам. трубы
6120-06-06	RHD 6 L	6mm
6120-08-08	RHD 8 L	8mm
6120-10-10	RHD 10 L	10mm
6120-12-12	RHD 12 L	12mm
6120-15-15	RHD 15 L	15mm
6120-18-18	RHD 18 L	18mm
6120-22-22	RHD 22 L	22mm
6120-28-28	RHD 28 L	28mm
6120-35-35	RHD 35 L	35mm
6120-42-42	RHD 42 L	42mm
6620-06-06	RHD 6 S	6mm
6620-08-08	RHD 8 S	8mm
6620-10-10	RHD 10 S	10mm
6620-12-12	RHD 12 S	12mm
6620-14-14	RHD 14 S	14mm
6620-16-16	RHD 16 S	16mm
6620-20-20	RHD 20 S	20mm
6620-25-25	RHD 25 S	25mm
6620-30-30	RHD 30 S	30mm
6620-38-38	RHD 38 S	38mm



Код	Тип	Диам. трубы	Резьба
6123-06-02	RHZ 6 L	6mm	G 1/8"
6123-08-04	RHZ 8 L	8mm	G 1/4"
6123-10-04	RHZ 10 L	10mm	G 1/4"
6123-12-06	RHZ 12 L	12mm	G 3/8"
6123-15-08	RHZ 15 L	15mm	G 1/2"
6123-18-08	RHZ 18 L	18mm	G 1/2"
6123-22-12	RHZ 22 L	22mm	G 3/4"
6123-28-16	RHZ 28 L	28mm	G 1"
6123-35-20	RHZ 35 L	35mm	G1 1/4"
6123-42-24	RHZ 42 L	42mm	G1 1/2"
6623-06-04	RHZ 6 S	6mm	G 1/4"
6623-08-04	RHZ 8 S	8mm	G 1/4"
6623-10-06	RHZ 10 S	10mm	G 3/8"
6623-12-06	RHZ 12 S	12mm	G 3/8"
6623-14-08	RHZ 14 S	14mm	G 1/2"
6623-16-08	RHZ 16 S	16mm	G 1/2"
6623-20-12	RHZ 20 S	20mm	G 3/4"
6623-25-16	RHZ 25 S	25mm	G 1"
6623-30-20	RHZ 30 S	30mm	G1 1/4"
6623-38-24	RHZ 38 S	38mm	G1 1/2"



Код	Тип	Диам. трубы	Резьба
6121-06-02	RHV 6 L	6mm	G 1/8"
6121-08-04	RHV 8 L	8mm	G 1/4"
6121-10-04	RHV 10 L	10mm	G 1/4"
6121-12-06	RHV 12 L	12mm	G 3/8"
6121-15-08	RHV 15 L	15mm	G 1/2"
6121-18-08	RHV 18 L	18mm	G 1/2"
6121-22-12	RHV 22 L	22mm	G 3/4"
6121-28-16	RHV 28 L	28mm	G 1"
6121-35-20	RHV 35 L	35mm	G1 1/4"
6121-42-24	RHV 42 L	42mm	G1 1/2"
6621-06-04	RHV 6 S	6mm	G 1/4"
6621-08-04	RHV 8 S	8mm	G 1/4"
6621-10-06	RHV 10 S	10mm	G 3/8"
6621-12-06	RHV 12 S	12mm	G 3/8"
6621-14-08	RHV 14 S	14mm	G 1/2"
6621-16-08	RHV 16 S	16mm	G 1/2"
6621-20-12	RHV 20 S	20mm	G 3/4"
6621-25-16	RHV 25 S	25mm	G 1"
6621-30-20	RHV 30 S	30mm	G1 1/4"
6621-38-24	RHV 38 S	38mm	G1 1/2"



Код	Тип	Резьба
6126-04-04	RHR	G 1/4"
6126-06-06	RHR	G 3/8"
6126-08-08	RHR	G 1/2"
6126-12-12	RHR	G 3/4"
6126-16-16	RHR	G 1"



Код	Тип	Резьба
6127-02-02	RHDI	G 1/8"
6127-04-04	RHDI	G 1/4"
6127-06-06	RHDI	G 3/8"
6127-08-08	RHDI	G 1/2"
6127-12-12	RHDI	G 3/4"
6127-16-16	RHDI	G 1"
6127-20-20	RHDI	G1 1/4"
6127-24-24	RHDI	G1 1/2"

АЛЬТЕРНАТИВНОЕ ДАВЛЕНИЕ ОТКРЫТИЯ
0,2, 0,5, 2 И 3 БАР
ПО ЗАПРОСУ

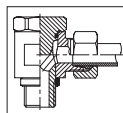

6110-00/03

**МЕТАЛЛИЧЕСКОЕ УПЛОТНИТЕЛЬНОЕ
КОЛЬЦО ДЛЯ ФИТИНГОВ ТИПА
БАНДЖО 6110 И 6116/ 6111**

Код	Размеры
6110-00-02	1/8"
6110-00-04	1/4"
6110-00-06	3/8"
6110-00-08	1/2"
6110-00-12	3/4"
6110-00-16	1"
6110-03-10	M10
6110-03-12	M12
6110-03-14	M14
6110-03-16	M16
6110-03-18	M18
6110-03-20	M20
6110-03-22	M22
6110-03-26	M26
6110-03-42	M 42 - G 1 1/4"
6110-03-48	M 48 - G 1 1/2"

Кольцевое
уплотнение

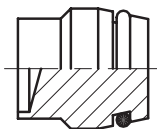

6130

**ПРОБКА С КОЛЬЦЕВЫМ
УПЛОТНЕНИЕМ ДЛЯ
ВНУТРЕННИХ КОНУСОВ
24°**

Код	Тип	Диам. трубы
6130-00-06	PL 6 L/S	6mm
6130-00-08	PL 8 L/S	8mm
6130-00-10	PL 10 L/S	10mm
6130-00-12	PL 12 L/S	12mm
6130-00-15	PL 15 L	15mm
6130-00-18	PL 18 L	18mm
6130-00-22	PL 22 L	22mm
6130-00-28	PL 28 L	28mm
6130-00-35	PL 35 L	35mm
6130-00-42	PL 42 L	42mm
6630-00-14	PL 14 S	14mm
6630-00-16	PL 16 S	16mm
6630-00-20	PL 20 S	20mm
6630-00-25	PL 25 S	25mm
6630-00-30	PL 30 S	30mm
6630-00-38	PL 38 S	38mm

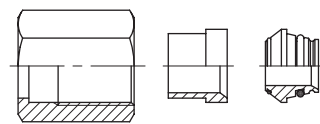

6131

**КОМПЛЕКТ АДАПТЕРА
Для фитингов с врезными кольцами с
конусом буртика фитинга 37°**

Код	Тип	Диам. трубы
6131-00-06	HOA 6 L	6mm
6131-00-08	HOA 8 L	8mm
6131-00-10	HOA 10 L	10mm
6131-00-12	HOA 12 L	12mm
6131-00-15	HOA 15 L	15mm
6131-00-18	HOA 18 L	18mm
6131-00-22	HOA 22 L	22mm
6131-00-28	HOA 28 L	28mm
6131-00-35	HOA 35 L	35mm
6131-00-42	HOA 42 L	42mm
6631-00-06	HOA 6 S	6mm
6631-00-08	HOA 8 S	8mm
6631-00-10	HOA 10 S	10mm
6631-00-12	HOA 12 S	12mm
6631-00-14	HOA 14 S	14mm
6631-00-16	HOA 16 S	16mm
6631-00-20	HOA 20 S	20mm
6631-00-25	HOA 25 S	25mm
6631-00-30	HOA 30 S	30mm
6631-00-38	HOA 38 S	38mm

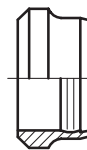

Кольцо с 2
последовательными
кромками

6149-01

**ВРЕЗНОЕ КОЛЬЦО
D
ВРЕЗНОЕ КОЛЬЦО С 2 КРОМКАМИ**

Код	Тип	Диам. трубы
6149-01-06	D 6 L/S	6mm
6149-01-08	D 8 L/S	8mm
6149-01-10	D 10 L/S	10mm
6149-01-12	D 12 L/S	12mm
6149-01-15	D 15 L	15mm
6149-01-18	D 18 L	18mm
6149-01-22	D 22 L	22mm
6149-01-28	D 28 L	28mm
6149-01-35	D 35 L	35mm
6149-01-42	D 42 L	42mm
6649-01-14	D 14 S	14mm
6649-01-16	D 16 S	16mm
6649-01-20	D 20 S	20mm
6649-01-25	D 25 S	25mm
6649-01-30	D 30 S	30mm
6649-01-38	D 38 S	38mm



Код	Тип	Диам. трубы	Резьба
6150-00-06	M 6 L	6mm	M12 x 1,5
6150-00-08	M 8 L	8mm	M14 x 1,5
6150-00-10	M 10 L	10mm	M16 x 1,5
6150-00-12	M 12 L	12mm	M18 x 1,5
6150-00-15	M 15 L	15mm	M22 x 1,5
6150-00-18	M 18 L	18mm	M26 x 1,5
6150-00-22	M 22 L	22mm	M30 x 2,0
6150-00-28	M 28 L	28mm	M36 x 2,0
6150-00-35	M 35 L	35mm	M45 x 2,0
6150-00-42	M 42 L	42mm	M52 x 2,0
6650-00-06	M 6 S	6mm	M14 x 1,5
6650-00-08	M 8 S	8mm	M16 x 1,5
6650-00-10	M 10 S	10mm	M18 x 1,5
6650-00-12	M 12 S	12mm	M20 x 1,5
6650-00-14	M 14 S	14mm	M22 x 1,5
6650-00-16	M 16 S	16mm	M24 x 1,5
6650-00-20	M 20 S	20mm	M30 x 2,0
6650-00-25	M 25 S	25mm	M36 x 2,0
6650-00-30	M 30 S	30mm	M42 x 2,0
6650-00-38	M 38 S	38mm	M52 x 2,0

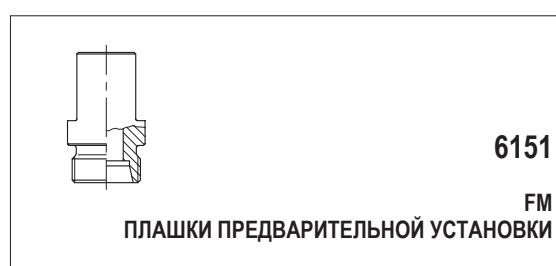

Код	Тип	Диам. трубы
6151-00-06	FM 6 L	6mm
6151-00-08	FM 8 L	8mm
6151-00-10	FM 10 L	10mm
6151-00-12	FM 12 L	12mm
6151-00-15	FM 15 L	15mm
6151-00-18	FM 18 L	18mm
6151-00-22	FM 22 L	22mm
6151-00-28	FM 28 L	28mm
6151-00-35	FM 35 L	35mm
6151-00-42	FM 42 L	42mm
6651-00-06	FM 6 S	6mm
6651-00-08	FM 8 S	8mm
6651-00-10	FM 10 S	10mm
6651-00-12	FM 12 S	12mm
6651-00-14	FM 14 S	14mm
6651-00-16	FM 16 S	16mm
6651-00-20	FM 20 S	20mm
6651-00-25	FM 25 S	25mm
6651-00-30	FM 30 S	30mm
6651-00-38	FM 38 S	38mm

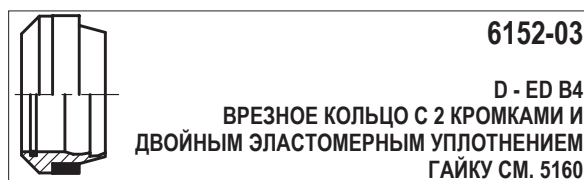

Код	Тип	Диам. трубы
6152-03-06	D - ED B4 6 L/S	6mm
6152-03-08	D - ED B4 8 L/S	8mm
6152-03-10	D - ED B4 10 L/S	10mm
6152-03-12	D - ED B4 12 L/S	12mm
6152-03-15	D - ED B4 15 L	15mm
6152-03-18	D - ED B4 18 L	18mm
6152-03-22	D - ED B4 22 L	22mm
6152-03-28	D - ED B4 28 L	28mm
6152-03-35	D - ED B4 35 L	35mm
6152-03-42	D - ED B4 42 L	42mm
6652-03-14	D - ED B4 14 S1	4mm
6652-03-16	D - ED B4 16 S	16mm
6652-03-20	D - ED B4 20 S	20mm
6652-03-25	D - ED B4 25 S	25mm
6652-03-30	D - ED B4 30 S	30mm
6652-03-38	D - ED B4 38 S	38mm

**Дополнительная информация
приводится на стр. 208.**

**ПРИМЕЧАНИЕ! Все фитинги с врезными кольцами могут
также поставляться без гайки и врезного кольца.**

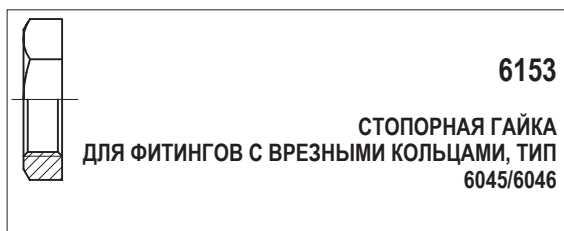

6153

**СТОПОРНАЯ ГАЙКА
ДЛЯ ФИТИНГОВ С ВРЕЗНЫМИ КОЛЬЦАМИ, ТИП
6045/6046**

Код Резьба

6153-00-12	M12 x 1,5
6153-00-14	M14 x 1,5
6153-00-16	M16 x 1,5
6153-00-18	M18 x 1,5
6153-00-20	M20 x 1,5
6153-00-22	M22 x 1,5
6153-00-24	M24 x 1,5
6153-00-26	M26 x 1,5
6153-00-30	M30 x 2,0
6153-00-36	M36 x 2,0
6153-00-42	M42 x 2,0
6153-00-45	M45 x 2,0
6153-00-52	M52 x 2,0

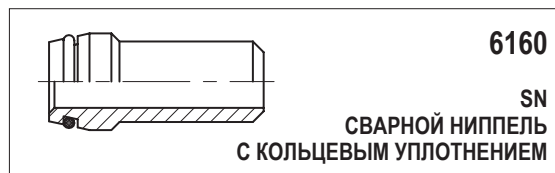

6160

**SN
СВАРНОЙ НИППЕЛЬ
С КОЛЬЦЕВЫМ УПЛОТНЕНИЕМ**

Код Тип Диам. трубы Толщина

6160-06-15	SN 6	6mm	1,75mm
6160-08-15	SN 8	8mm	1,5mm
6160-10-20	SN 10	10mm	2,0mm
6160-12-20	SN 12	12mm	2,5mm
6160-16-20	SN 16	16mm	2,0mm
6160-16-25	SN 16	16mm	2,5mm
6160-16-30	SN 16	16mm	3,0mm
6160-20-25	SN 20	20mm	2,5mm
6160-20-30	SN 20	20mm	3,0mm
6160-20-40	SN 20	20mm	4,0mm
6160-25-30	SN 25	25mm	3,0mm
6160-25-40	SN 25	25mm	4,0mm
6160-30-40	SN 30	30mm	4,0mm
6160-30-50	SN 30	30mm	5,0mm
6160-38-50	SN 38	38mm	5,0mm



6160-50

**КОЛЬЦЕВОЕ УПЛОТНЕНИЕ
ДЛЯ ФИТИНГА ТИПА 6160**

Код Тип Размеры

6160-50-10	SN 10	10mm
6160-50-12	SN 12	12mm
6160-50-16	SN 16	16mm
6160-50-20	SN 20	20mm
6160-50-25	SN 25	25mm
6160-50-30	SN 30	30mm
6160-50-38	SN 38	38mm